

Brochure Holders

International Ltd



2018 Product Catalogue

Contents

Counter Standing

Wall Mounting

Tilt Slant (Counter/Wall/Slatwall)

Business Card Holders

Single Page Displays

Outdoor Leaflet Holders

Rotating Displays

Floor Stands

Clips & Accessories

Information | Terms | Product Index

Counter Standing

- Single Pocket Portrait
- Single Pocket Landscape
- Multi-Pocket:
 - 2 Pocket
 - 3 Pocket
 - 4+ Pocket
 - Mixed & Combination Paper Sizes

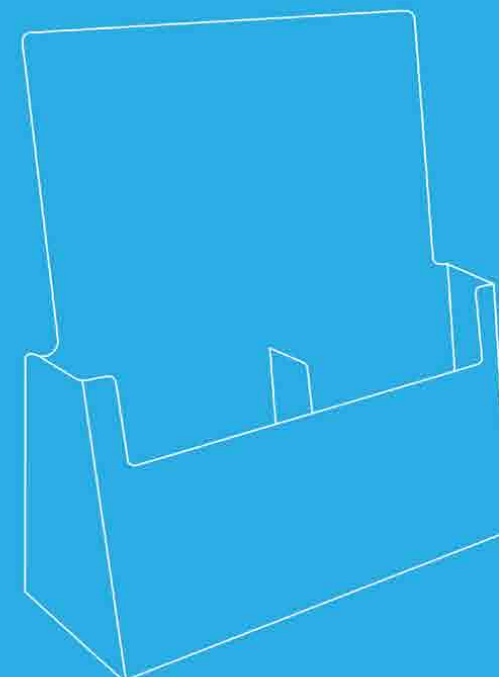

Single Pocket Portrait



Product code	Description	Pocket Opening Dims. (mm)	External Product Dims. (mm)
C110	1 pocket 1/3rd A4/DL portrait leaflet holder	110 x 32mm	H: 181 x W: 114 x D: 65
C160	1 pocket A5 portrait leaflet holder	160 x 32mm	H: 214 x W: 165 x D: 75
C230	1 pocket A4 portrait leaflet holder	230 x 32mm	H: 249 x W: 223 x D: 85

Product code	Description	Pocket Opening Dims. (mm)	External Product Dims. (mm)
W110	1 pocket DL portrait leaflet holder (counter or wall)	110 x 32mm	H: 181 x W: 114 x D: 65
W160	1 pocket A5 portrait leaflet holder (counter or wall)	160 x 32mm	H: 214 x W: 165 x D: 75
W230	1 pocket A4 portrait leaflet holder (counter or wall)	230 x 32mm	H: 249 x W: 223 x D: 85
WPA6	1 pocket A6 portrait leaflet holder (counter or wall)	110 x 32mm	H: 120 x W: 115 x D: 38

Product code	Image	Carton Quantity	Carton Size (cm)	Carton Size (m3)	Carton Weight (kg)
C110		80	25x70x38	0.07	9
C160		80	35x82x46	0.11	15
C230		36	25x81x52	0.11	12



Product code	Image	Carton Quantity	Carton Size (cm)	Carton Size (m3)	Carton Weight (kg)
W110		100	25x99x32	0.08	15
W160		88	35x81x40	0.12	15
W230		44	25x86x53	0.11	15
WPA6		80	28x60x35	0.06	8



AB1 Removable Counter Standing Clip

- Supplied with W110, W160, W230 and WPA6

The products above are supplied with a removable counter stand allowing the leaflet holders to be placed on the counter top or mounted to the wall.



Single Pocket Landscape



Product code	Description	Pocket Opening Dims. (mm)	External Product Dims. (mm)
CL230	1 pocket 1/3rd A4/DL landscape leaflet holder	230 x 32mm	H: 74 x W: 237 x D: 60
CLA5	1 pocket A5 landscape leaflet holder	230 x 32mm	H: 135 x W: 235 x D: 135
C330	1 pocket A4 landscape leaflet holder	330 x 32mm	H: 186 x W: 340 x D: 78

Product code	Description	Pocket Opening Dims. (mm)	External Product Dims. (mm)
WLA6	1 pocket A6 landscape leaflet holder (counter or wall)	160 x 32mm	H: 120 x W: 160 x D: 38

Product code	Image	Carton Quantity	Carton Size (cm)	Carton Size (m3)	Carton Weight (kg)
CL230		48	57x33x46	0.15	8
CLA5		48	28x72x37	0.07	9
C330		24	73x36x39	0.12	10



Product code	Image	Carton Quantity	Carton Size (cm)	Carton Size (m3)	Carton Weight (kg)
WLA6		56	28x60x35	0.06	8

WLA6: Supplied with AB1 Clip

The WLA6 is supplied with a removable counter stand (AB1) allowing the leaflet holder to be placed on the counter top or mounted to the wall.

Flat Pack

Product code	Description	Pocket Opening Dims. (mm)	External Product Dims. (mm)
FP110	1 pocket 1/3rd A4/DL flat pack leaflet holder	110 x 32mm	H: 181 x W: 114 x D: 65

Product code	Image	Carton Quantity	Carton Size (cm)	Carton Size (m3)	Carton Weight (kg)
FP110		100	14x33x50	0.03	8

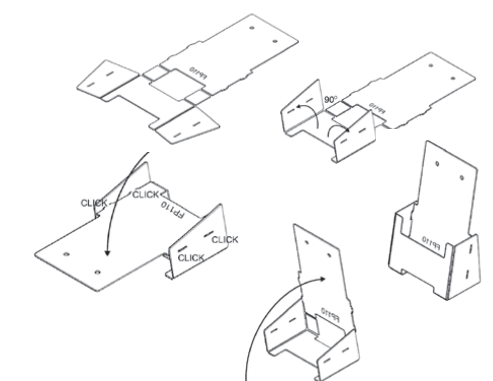

Multi-Pocket: 2 Pocket



Product code	Description	Pocket Opening Dims. (mm)	External Product Dims. (mm)
2C110	2 pocket 1/3rd A4/DL portrait leaflet holder	110 x 48mm	H: 270 x W: 115 x D: 120
2C112	2 pocket 1/3rd A4/DL portrait leaflet holder	112 x 32mm	H: 249 x W: 233 x D: 85
2C155H	2 pocket A5 portrait leaflet holder - side by side	160 x 32mm	H: 186 x W: 340 x D: 78
2C160	2 pocket A5 portrait leaflet holder	160 x 48mm	H: 249 x W: 164 x D: 118
2C230	2 pocket A4 or 4 pocket DL - pocket dividers incl.	230 x 32mm	H: 285 x W: 236 x D: 120
2C230X	2 pocket A4 portrait leaflet holder	230 x 32mm	H: 285 x W: 236 x D: 120
2CA6	2 pocket A6 portrait leaflet holder - side by side	112 x 32mm	H: 135 x W: 235 x D: 65

Product code	Image	Carton Quantity	Carton Size (cm)	Carton Size (m3)	Carton Weight (kg)
2C110		32	53x55x36	0.11	11
2C112		36	25x86x52	0.11	13
2C155H		24	73x36x39	0.12	10
2C160		24	74x37x45	0.12	10
2C230		16	60x48x52	0.15	12
2C230X		16	60x48x52	0.15	12
2CA6		48	25x73x40	0.07	10



CD
Removable pocket dividers. Use with **2C230X** to convert A4 pockets to DL pockets

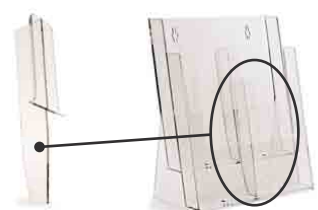

See page 35

Screen Printing
Interested in personalising Taymar leaflet holders?

Please contact us for more information



Multi-Pocket: 3 Pocket



Product code	Description	Pocket Opening Dims. (mm)	External Product Dims. (mm)
3C104	3 pocket 1/3rd A4/DL portrait leaflet holder	104 x 32mm	H: 218 x W: 109 x D: 112
3C110H	3 pocket 1/3rd A4/DL portrait leaflet holder	112 x 32mm	H: 186 x W: 340 x D: 78
3C160	3 pocket A5 portrait leaflet holder - side by side	160 x 32mm	H: 256 x W: 166 x D: 110
3C230	3 pocket A5 portrait leaflet holder	160 x 32mm	H: 339 x W: 237 x D: 155

Product code	Image	Carton Quantity	Carton Size (cm)	Carton Size (m3)	Carton Weight (kg)
3C104		20	26x59x41	0.06	8
3C110H		24	73x36x39	0.12	10
3C160		18	38x40x53	0.08	10
3C230		12	51x70x53	0.19	14



CD
Removable pocket dividers. Use with **3C230** to convert A4 pockets to DL pockets

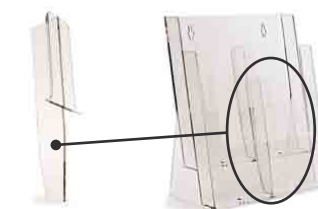

See page 35

CWBC93
One pocket landscape clip-on business card holder. Simply clip to the front of **any Taymar brochure holder**.

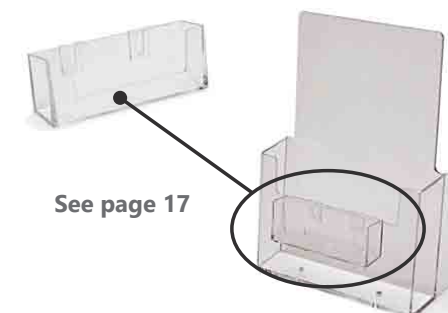

See page 17

Multi-Pocket: 4 Pocket



Product code	Description	Pocket Opening Dims. (mm)	External Product Dims. (mm)
4C110	4 pocket 1/3rd A4/DL portrait leaflet holder	110 x 32mm	H: 270 x W: 115 x D: 120
4C160	4 pocket A5 portrait leaflet holder	112 x 32mm	H: 249 x W: 233 x D: 85
4C230	4 pocket A4 or 8 pocket DL - pocket dividers included	160 x 32mm	H: 186 x W: 340 x D: 78
4C230X	4 pocket A4 portrait leaflet holder	160 x 32mm	H: 249 x W: 164 x D: 118
4C330	4 pocket A4 or 8 pocket A5 or 12 pocket DL *	230 x 32mm	H: 285 x W: 236 x D: 120
4C330X	4 pocket A4 landscape leaflet holder	230 x 32mm	H: 285 x W: 236 x D: 120
4W104	4 pocket DL leaflet holder - side by side (counter or wall)	112 x 32mm	H: 135 x W: 235 x D: 65

Product code	Image	Carton Quantity	Carton Size (cm)	Carton Size (m3)	Carton Weight (kg)
4C110		20	26x83x49	0.11	8
4C160		18	51x53x46	0.14	11
4C230		8	51x58x40	0.12	10
4C230X		8	51x58x40	0.12	9
4C330		8	72x70x45	0.23	15
4C330X		8	72x70x45	0.23	13
4W104		24	33x48x44	0.06	12



***4C330 pocket divider positioning**

The 4C330 is supplied with 8 x removable pocket dividers. Without dividers each tier will accommodate A4 landscape. With one central divider in place the pocket is converted to 2 x A5. With 2 dividers in place each pocket converts to 3 x DL (middle image). Each pocket can be converted individually allowing multiple paper sizes to be displayed.

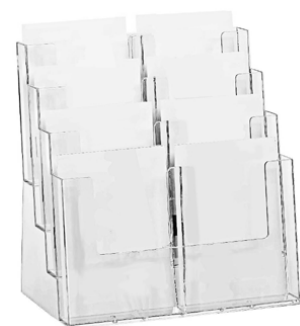

For Mixed & Combination Paper Sizes

A4&DL

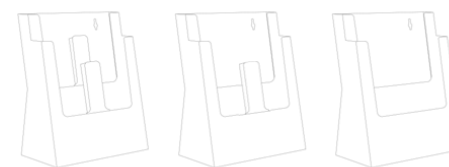

Product code	Description	Pocket Opening Dims. (mm)	External Product Dims. (mm)
2C230	2 pocket A4 or 4 pocket DL - pocket dividers included	110 x 32mm or 230 x 32mm	H: 270 x W: 115 x D: 120
4C230	4 pocket A4 or 8 pocket DL - pocket dividers included	110 x 32mm or 230 x 32mm	H: 249 x W: 233 x D: 85

Product code	Image	Carton Quantity	Carton Size (cm)	Carton Size (m3)	Carton Weight (kg)	
2C230		16	60x48x52	0.15	12	One or both of the pockets can be converted from A4 to DL by inserting the pocket dividers included.
4C230		8	51x58x40	0.12	10	One, two, three or all four of the pockets can be converted from A4 to DL by inserting the pocket dividers included.

A4&A5&DL



Product code	Description	Pocket Opening Dims. (mm)	External Product Dims. (mm)
4C330	4 pocket A4 or 8 pocket A5 or 12 pocket DL	110 x 32mm or 230 x 32mm or 160 x 32mm	H: 249 x W: 233 x D: 85

Product code	Image	Carton Quantity	Carton Size (cm)	Carton Size (m3)	Carton Weight (kg)	
4C330		8	72x70x45	0.23	15	One, two, three or all four of the pockets can be converted from A4 to either DL or A5 by inserting the pocket dividers included.

Wall Mounting

- Single Pocket Portrait
- Single Pocket Landscape
- Multi-Pocket
- Wall Display Systems

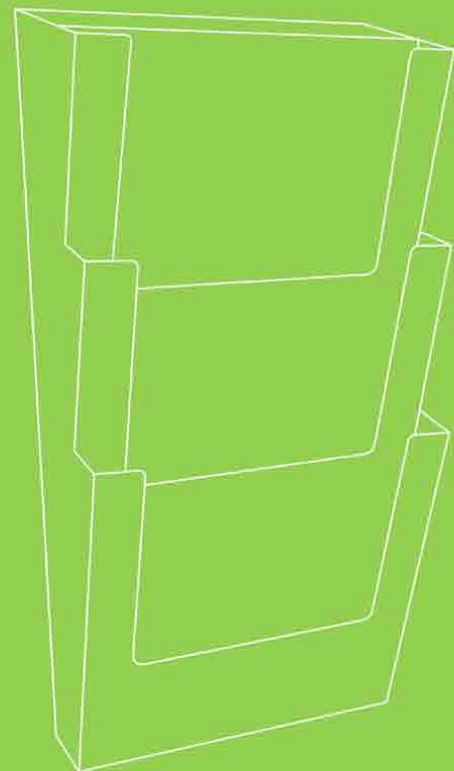

Single Pocket Portrait



Product code	Description	Pocket Opening Dims. (mm)	External Product Dims. (mm)
W110X	1 pocket 1/3rd A4/DL portrait leaflet holder	110 x 32mm	H: 150 x W: 115 x D: 40
W160X	1 pocket A5 portrait leaflet holder	160 x 32mm	H: 191 x W: 165 x D: 35
W230X	1 pocket A4 portrait leaflet holder	230 x 32mm	H: 250 x W: 240 x D: 40
WPA6X	1 pocket A6 portrait leaflet holder	110 x 32mm	H: 120 x W: 115 x D: 38

Product code	Description	Pocket Opening Dims. (mm)	External Product Dims. (mm)
CL-108	1 pocket 1/3rd A4 portrait leaflet holder	108 x 32mm	H: 192 x W: 112 x D: 35
CL-152	1 pocket A5 portrait leaflet holder	152 x 32mm	H: 192 x W: 152 x D: 35
CL-223	1 pocket A4 portrait leaflet holder	223 x 32mm	H: 278 x W: 223 x D: 35

Product code	Image	Carton Quantity	Carton Size (cm)	Carton Size (m3)	Carton Weight (kg)
W110X		100	25x99x32	0.08	12
W160X		88	35x81x40	0.12	13
W230X		44	25x86x53	0.11	15
WPA6X		80	28x60x35	0.06	7

Product code	Image	Carton Quantity	Carton Size (cm)	Carton Size (m3)	Carton Weight (kg)
CL-108		40	41x34x24	0.03	4
CL-152		40	40x35x33	0.05	4.5
CL-223		40	57x33x46	0.09	6.5

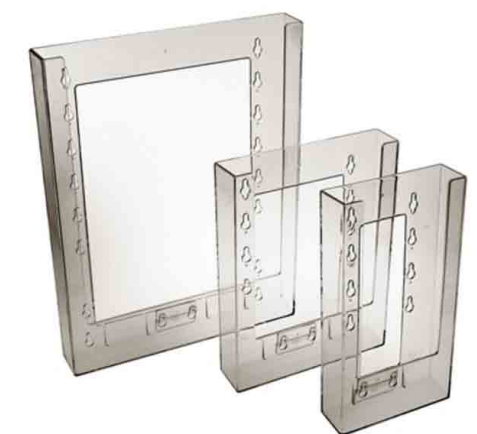

Single Pocket Landscape



Product code	Description	Pocket Opening Dims. (mm)	External Product Dims. (mm)
WL230	1 pocket 1/3rd A4/DL landscape leaflet holder	230 x 32mm	H: 74 x W: 237 x D: 35
WLA5	1 pocket A5 landscape leaflet holder	230 x 32mm	H: 135 x W: 235 x D: 35
W330	1 pocket A4 landscape leaflet holder	330 x 32mm	H: 186 x W: 340 x D: 38
WLA6X	1 pocket A6 landscape leaflet holder	160 x 32mm	H: 120 x W: 165 x D: 38

Product code	Image	Carton Quantity	Carton Size (cm)	Carton Size (m3)	Carton Weight (kg)
WL230		84	28x37x71	0.12	12
WLA5		84	28x71x37	0.07	14
W330		36	41x69x36	0.11	13
WLA6X		56	28x60x35	0.06	7



CLW
Join Taymar wall mounted pockets together using CLW joining clips.



Use with **W110X, W160X, W230X, W330, WLA6X** and more.
See page 35



SWB1
SWB1 brackets allow Taymar wall mounted leaflet holders to be fixed to slatwall



Use with **W110X, W160X, W230X, W330, WLA6X** and more.
See page 35



HB1
HB1 brackets allow Taymar wall mounted leaflet holders to be fixed to wire frame work



Use with **W110X, W160X, W230X, W330, WLA6X** and more.
See page 35

Multi-Pocket



Product code	Description	Pocket Opening Dims. (mm)	External Product Dims. (mm)
3W110H	3 pocket 1/3rd A4/DL portrait leaflet holder	110 x 32mm	H: 186 x W: 340 x D: 38
4W104	4 pocket 1/3rd A4 portrait leaflet holder	104 x 32mm	H: 150 x W: 425 x D: 65
2W155H	2 pocket A5 portrait leaflet holder	160 x 32mm	H: 186 x W: 340 x D: 38
3W230	3 pocket A4 portrait leaflet holder	230 x 32mm	H: 535 x W: 237 x D: 102
2WA6	2 pocket A6 portrait leaflet holder	112 x 32mm	H: 135 x W: 235 x D: 35

Product code	Image	Carton Quantity	Carton Size (cm)	Carton Size (m3)	Carton Weight (kg)
3W110H		36	70x41x36	0.11	14
4W104		24	33x48x44	0.06	12
2W155H		36	70x41x36	0.11	13
3W230		12	51x70x53	0.19	17
2WA6		84	28x72x37	0.07	16



For the wall or counter top

The following products can also be wall mounted using the keyholes or screwholes included in the rear panel:

3C104 - screw holes
1/3rdA4/DL
See page 5



2C160 - keyholes
A5
See page 4



3C160 - screw holes
A5
See page 5



4C160 - screw holes
A5
See page 6



2C230 - keyholes
DL | A4
See page 4 / 7



4C230 - screw holes
DL | A4
See page 6 / 7



4C330 - keyholes
DL | A5 | A4
See page 6 / 7



Wall Display Systems



Product code	Description	Pocket Opening Dims. (mm)	External Product Dims. (mm)
WS16-D8	16 pocket A4 / DL portrait leaflet holder	230 x 32mm / 108 x 32mm	H: 640 x W: 950 x D: 160
CL-KIT1	8 pocket A4 portrait leaflet holder	223 x 32mm	H: 510-820 x W: 440 x D: 130
CL-KIT2	12 pocket A5 portrait leaflet holder	152 x 32mm	H: 310-500 x W: 465 x D: 130
CL-KIT3	16 pocket 1/3rdA4 portrait leaflet holder	160 x 32mm	H: 310-500 x W: 465 x D: 130
CL-KIT4	48 pocket A4 / 1/3rdA4 portrait leaflet holder	223 x 32mm / 108 x 32mm	H: 510-820 x W: 440 x D: 130
CL-KIT5	16 pocket A4 portrait leaflet holder	223 x 32mm	H: 1020-1640 x W: 440 x D: 130
CL-KIT6	36 pocket A5 portrait leaflet holder	152 x 32mm	H: 570-1380 x W: 465 x D: 130
CL-KIT7	48 pocket 1/3rdA4 portrait leaflet holder	108 x 32mm	H: 570-1380 x W: 465 x D: 130

Product code	Image	Carton Quantity	Carton Size (cm)	Carton Size (m3)	Carton Weight (kg)
WS16-D8		1	99x32x24	0.08	10
CL-KIT1		1	46x24x48	0.03	1.6
CL-KIT2		1	46x24x48	0.03	2.1
CL-KIT3		1	46x24x48	0.03	2.6
CL-KIT4		1	46x24x48	0.03	2.2
CL-KIT5		1	51x46x31	0.07	3.7
CL-KIT6		1	51x46x31	0.07	5.1
CL-KIT7		1	40x34x32	0.04	5.1



Wall Display Systems



ClipLock Wall Display Kit - Mounting options

All ClipLock Wall Display Kits (CL-KITS) are supplied with Wall Rail Mounting fixings as standard - either 'vertical' or 'leaning'. Other mounting options are explained below:

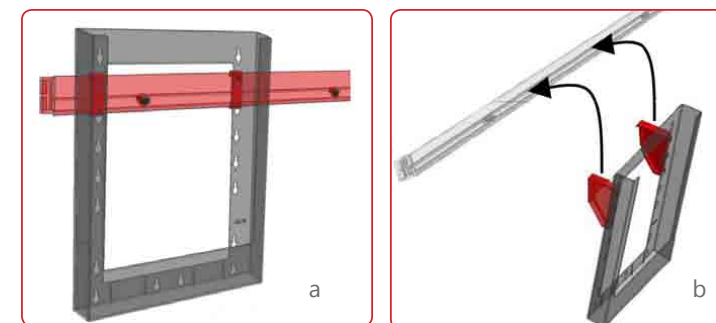

Wall Rail Mounting

All ClipLock Wall Display Kits will be supplied with Wall Rail Mountings as standard.

Vertical Wall Rail Mounting (a).
Supplied as standard with kits 1, 2, 3 & 4.

Leaning Wall Rail Mounting (b).
Supplied with Kits 5, 6 and 7 as standard.

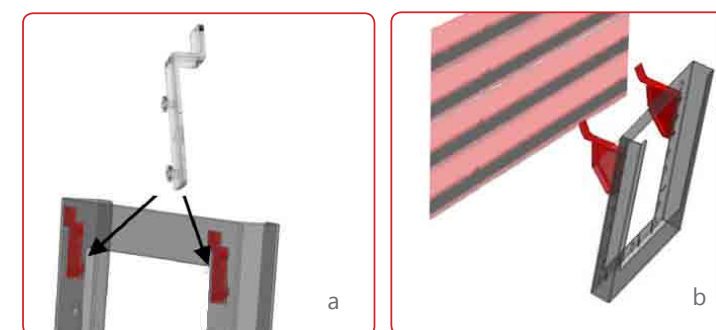

Slatwall Mounting

ClipLock kits can be installed on your existing Slatwall Display System.

Vertical Slatwall Mounting (a).
Compatible with kits 1, 2, 3 & 4.

Leaning Slatwall Mounting (b).
Compatible with all kits.

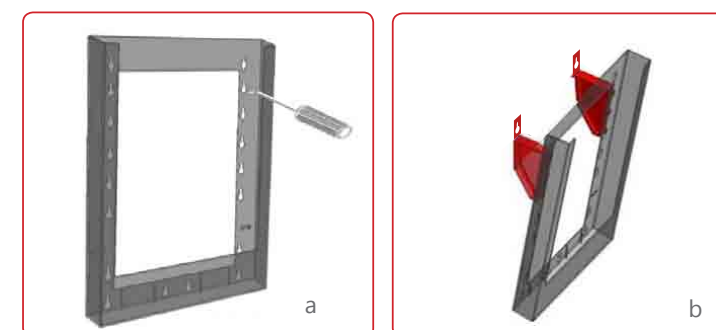

Direct To Wall Mounting

Screw each pocket in the top row directly to the wall.

Vertical Direct To Wall Mounting (a).
No mounting clips required. Pockets are screwed directly to the wall. Compatible with kits 1, 2, 3 & 4.

Leaning Direct To Wall Mounting (b).
Compatible with all kits.

CL-VSC - vertical display

CL-VSC brackets allow ClipLock wall display kits to be fixed to slatwall



Use with **CL-KIT1, CL-KIT2, CL-KIT3, and CL-KIT4.**

See page 36

CL-LSB - leaning display

CL-LSB brackets allow ClipLock wall display kits to be fixed to slatwall



Use with **all CL-KITS**

See page 36

CL-LKB - leaning display

CL-LKB brackets allow ClipLock wall display kits to be fixed directly to the wall using screws.



Use with **all CL-KITS**

See page 36

Tilt Slant

Brochure holders with multiple mounting options and suitable for oversized literature

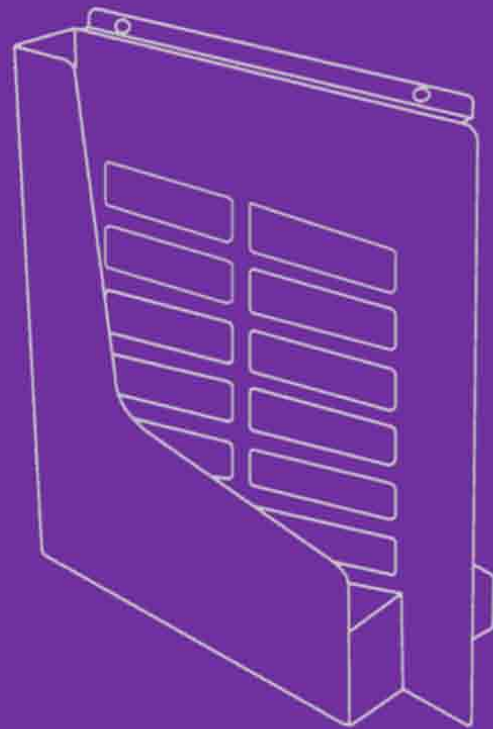

Tilt Slant - for counter, wall or slatwall

taymar[®]
brochure holders

Product code	Description	Pocket Opening Dims. (mm)	External Product Dims. (mm)
TS110	1 pocket 1/3rd A4/DL portrait leaflet holder	32mm depth - open sided	H: 181 x W: 115 x D: 83
TS160	1 pocket A5 portrait leaflet holder	32mm depth - open sided	H: 135 x W: 235 x D: 35
TS230	1 pocket A4 portrait leaflet holder	32mm depth - open sided	H: 181 x W: 165 x D: 83

Product code	Image	Carton Quantity	Carton Size (cm)	Carton Size (m3)	Carton Weight (kg)
TS110		40	67x42x23	0.08	6
TS160		40	67x44x34	0.11	7
TS230		32	109x36x50	0.20	10

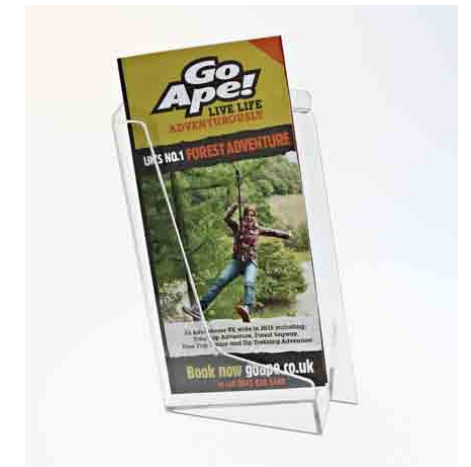

Tilt Slant

The multi-purpose Tilt Slant collection from Taymar combines extra flexibility with an alternative slanting design for extra attraction:

Multiple Mounting Options:

These 3-in-1 dispensers can be **wall** mounted, placed on **counter** top or fixed to your **slatwall** system.



counter top
mounting



wall mounting
screw holes



slatwall fixing

Oversized Leaflets:

Tilt Slant holders are open-ended meaning they can accommodate unusual or slightly oversized leaflets.



Business Card

- Counter Standing
- Wall Mounting
- Clip-On

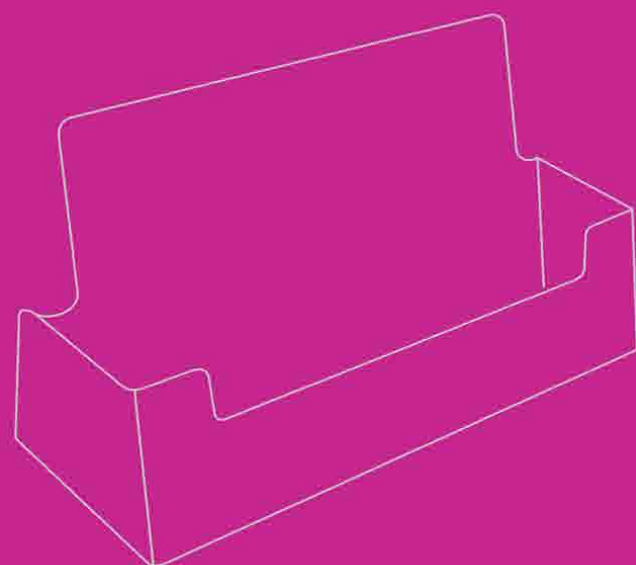

Business Card Holders

Product code	Description	Pocket Opening Dims. (mm)	External Product Dims. (mm)
BC93	1 pocket landscape business card holder - counter top	93 x 18mm	H: 53 x W: 102 x D: 38
VBC56	1 pocket portrait business card holder - counter top	56 x 19mm	H: 71 x W: 63 x D: 37
4BC93	4 pocket landscape business card holder - counter top	93 x 18mm	H: 90 x W: 100 x D: 100
8BC93	8 pocket landscape business card holder - counter top	93 x 18mm	H: 90 x W: 197 x D: 100
WBC93	1 pocket landscape business card holder - wall mounting	93 x 18mm	H: 37 x W: 101 x D: 23
NB93	1 pocket landscape business card holder - no back panel	56 x 19mm	H: 37 x W: 100 x D: 23
CWBC93	1 pocket landscape business card holder - Clip-On	93 x 18mm	H: 37 x W: 101 x D: 23

Product code	Image	Carton Quantity	Carton Size (cm)	Carton Size (m3)	Carton Weight (kg)
BC93		250	28x52x20	0.03	7
VBC56		280	28x52x20	0.03	8
4BC93		72	43x36x36	0.06	7
8BC93		36	43x36x36	0.06	7

Product code	Image	Carton Quantity	Carton Size (cm)	Carton Size (m3)	Carton Weight (kg)
WBC93		250	28x52x20	0.03	7
NB93		130	17x36x15	0.01	2
CWBC93		280	26x54x22	0.03	6



OD110 - Outdoor Business Card Holder
Weather resistant with multiple fixing options.
See page 25

Single Page Displays

Menu holders, notice holders and advertisement displays. Single and double sided options are available for a variety of paper sizes.

- Vertical - 'L' range
- Vertical - 'M' range
- Leaning - 'L' range
- Ad-Print
- Wall / Window Mounting
- Place Card Holder

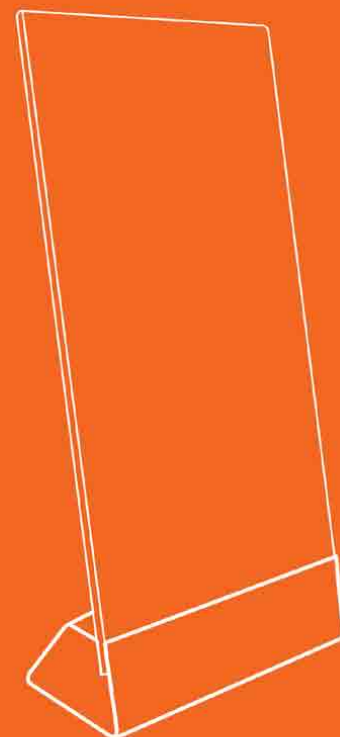

Vertical - 'V' range

Product code	Description	To Hold Sheet Size. (mm)	External Product Dims. (mm)
V100	1/3rd A4 Menu Holder - with PVC	210 x 100mm	H: 220 x W: 100 x D: 50
V150	A5 Menu Holder - with PVC	210 x 148mm	H: 228 x W: 152 x D: 63
V210	A4 Menu Holder - with PVC	297 x 210mm	H: 330 x W: 212 x D: 86
V100B	1/3rd A4 Menu Holder - base only		H: 26 x W: 100 x D: 50
V150B	A5 Menu Holder - base only		H: 33 x W: 152 x D: 63
V210B	A4 Menu Holder - base only		H: 44 x W: 212 x D: 86

Product code	Image	Carton Quantity	Carton Size (cm)	Carton Size (m3)	Carton Weight (kg)
V100		200	31x24x43	0.03	1.4
V150		80	31x24x43	0.03	10
V210		40	31x24x43	0.03	11

The above Product codes are **supplied with PVC**



Product code	Base Profile	Carton Quantity	Carton Size (cm)	Carton Size (m3)	Carton Weight (kg)
V100B		260	31x24x43	0.03	8
V150B		100	31x24x43	0.03	6
V210B		50	31x24x43	0.03	5

The above Product codes **do not include PVC**





Vertical - 'M' range





Product code	Description	To Hold Sheet Size. (mm)	External Product Dims. (mm)
M120	120mm Menu Holder - with PVC	135 x 120mm	H: 160 x W: 125 x D: 50
M160	A5 Menu Holder - with PVC	210 x 150mm	H: 228 x W: 155 x D: 62
M210	A4 Menu Holder - with PVC	297 x 210mm	H: 330 x W: 218 x D: 87

M120B	120mm Menu Holder - base only		H: 25 x W: 125 x D: 50
M160B	A5 Menu Holder - base only		H: 32 x W: 155 x D: 62
M210B	A4 Menu Holder - base only		H: 44 x W: 218 x D: 87

Product code	Image	Carton Quantity	Carton Size (cm)	Carton Size (m3)	Carton Weight (kg)
M120		192	37x35x30	0.04	14
M160		144	79x33x24	0.06	17
M210		72	79x33x24	0.06	18



The above Product codes are **supplied with PVC**

Product code	Base Profile	Carton Quantity	Carton Size (cm)	Carton Size (m3)	Carton Weight (kg)
M120B		256	37x35x30	0.04	9
M160B		192	79x33x24	0.06	10
M210B		96	79x33x24	0.06	8





The above Product codes **do not include PVC**

Leaning - 'L' range





Product code	Description	To Hold Sheet Size. (mm)	External Product Dims. (mm)
L100	1/3rd A4 Menu Holder - with PVC	210 x 100mm	H: 215 x W: 100 x D: 50
L150	A5 Menu Holder - with PVC	210 x 148mm	H: 223 x W: 150 x D: 60
L210	A4 Menu Holder - with PVC	297 x 210mm	H: 325 x W: 210 x D: 85

L100B	1/3rd A4 Menu Holder - base only		H: 25 x W: 100 x D: 50
L150B	A5 Menu Holder - base only		H: 33 x W: 150 x D: 60
L210B	A4 Menu Holder - base only		H: 45 x W: 210 x D: 85

Product code	Image	Carton Quantity	Carton Size (cm)	Carton Size (m3)	Carton Weight (kg)
L100		200	31x24x43	0.03	13
L150		80	31x24x43	0.03	9
L210		40	31x24x43	0.03	11



The above Product codes are **supplied with PVC**

Product code	Base Profile	Carton Quantity	Carton Size (cm)	Carton Size (m3)	Carton Weight (kg)
L100B		260	31x24x43	0.03	7
L150B		100	31x24x43	0.03	6
L210B		50	31x24x43	0.03	5



The above Product codes **do not include PVC**



Base Only Product codes

All base only Product codes are supplied without PVC. Bases are suitable for use with oversized or die-cut cards providing the thickness is correct to ensure a tight fit. Please contact us specifications.

Ad-Print

taymar
brochure holders

Product code	Description	To Hold Sheet Size. (mm)	External Product Dims. (mm)
AP150	A5 Angled Ad-Print - with PVC	210 x 148mm	H: 250 x W: 158 x D: 80
AP210	A4 Angled Ad-Print - with PVC	297 x 210mm	H: 331 x W: 220 x D: 100

Product code	Image	Carton Quantity	Carton Size (cm)	Carton Size (m3)	Carton Weight (kg)
AP150		60	51x41x17	0.04	11
AP210		60	59x41x24	0.06	22

The above Product codes are **supplied with PVC**

Both the AP150 and AP210 can be used in landscape



Wall / Window Mounting

taymar
brochure holders

Product code	Description	To Hold Sheet Size. (mm)	External Product Dims. (mm)
NH210	A4 Notice Holder with PVC. For wall / window mounting	297 x 210mm	H: 305 x W: 216 x D: 4

Product code	Image	Carton Quantity	Carton Size (cm)	Carton Size (m3)	Carton Weight (kg)
NH210		30	15x23x32	0.02	7

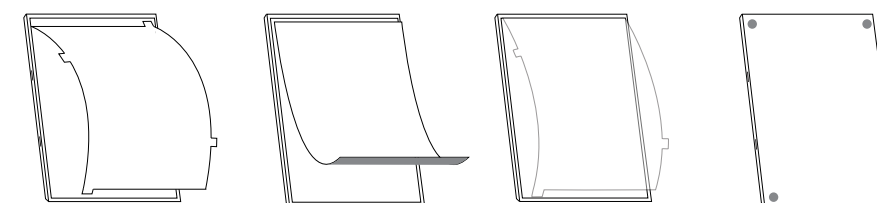

Mounting

The NH210 is completely clear and can therefore be mounted onto a window creating a double sided display. Adhesive pads are supplied with the unit and are suitable for mounting the NH210 onto a wall, board or window.

Place Card Holder

Product code	Description	External Product Dims. (mm)
PC260	Place card holder - 80mm wide.	H: 25 x W: 100 x D: 50

Product code	Image	Carton Quantity	Carton Size (cm)	Carton Size (m3)	Carton Weight (kg)
PC260		140	13x24x19	0.01	2



Outdoor Leaflet Holders

Outdoor Leaflet Holders

A range of water resistant leaflet holders for DL, A5, A4 and Business Cards

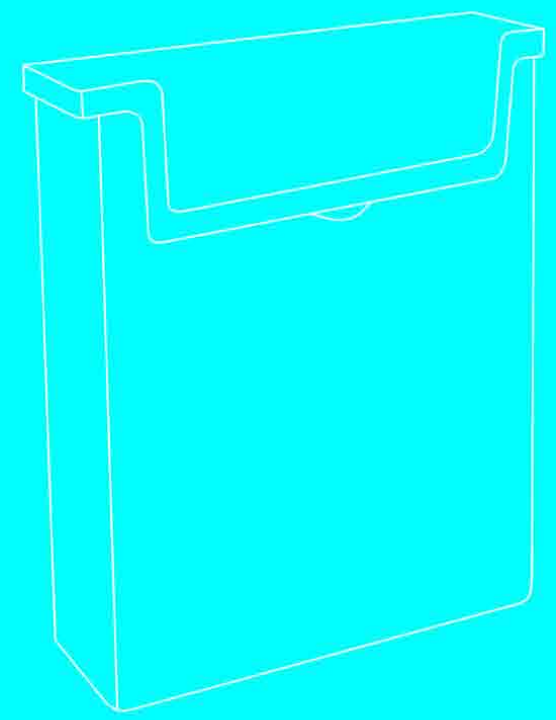

Product code	Description	Pocket Opening Dims. (mm)	External Product Dims. (mm)
OD95	Landscape Outdoor Business Card Holder	95 x 25mm	H: 62 x W: 106 x D: 32
OD110	1/3rd A4/DL Portrait Outdoor Leaflet Holder	110 x 32mm	H: 227 x W: 113 x D: 34
OD160	A5 Portrait Outdoor Leaflet Holder	160 x 32mm	H: 227 x W: 165 x D: 44
OD230	A4 Portrait Outdoor Leaflet Holder	230 x 32mm	H: 320 x W: 240 x D: 48

Product code	Image	Carton Quantity	Carton Size (cm)	Carton Size (m3)	Carton Weight (kg)
OD95		40	43x25x16	0.02	3
OD110		20	23x35x27	0.02	4
OD160		20	25x49x39	0.04	6
OD230		20	34x61x53	0.11	13



Hanging Clips

Taymar car window / hanging clips slide into the keyholes allowing the holders to be fixed to car windows or simply hung from existing display fittings.

See page 35



Surface Mounting

Surface mounting clips can then be fixed to any surface using adhesive or doubled sided tape.

See page 35

Rotating Displays

- Desktop Spinners
- Floor Standing Carousels
- Components

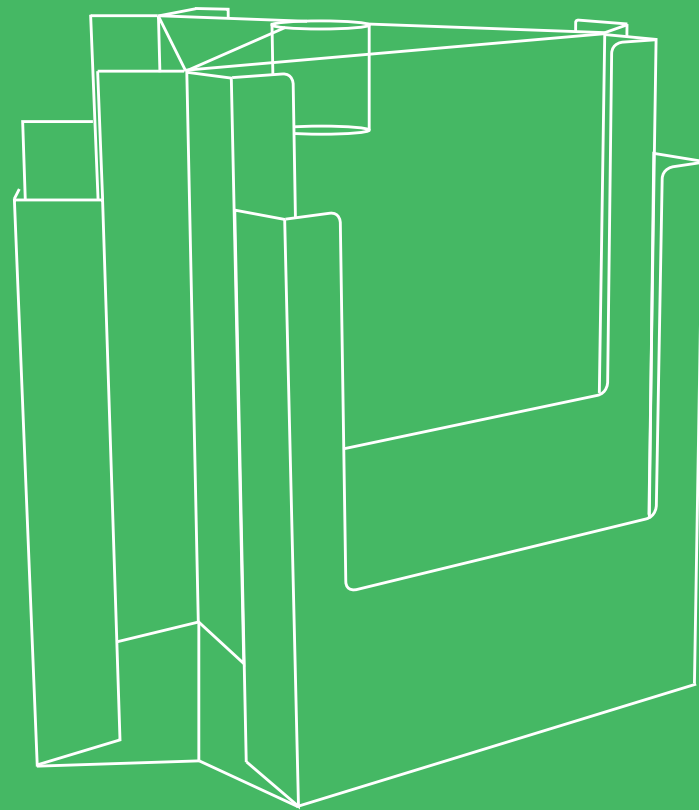

Desktop Spinners



Product code	Description	Pocket Opening Dims. (mm)	External Product Dims. (mm)
6RC230C	6 Pocket A4 Desktop Spinner (pocket dividers available)	230 x 32mm	H: 320 x W: 360 x D: 360



Product code	Description	Pocket Opening Dims. (mm)	External Product Dims. (mm)
12C230	12 Pocket A4 Desktop Spinner (pocket dividers available)	230 x 32mm	H: 320 x W: 360 x D: 360

CD
Removable pocket dividers. Use with **12C230** and **6RC230C** to convert A4 pockets to DL pockets

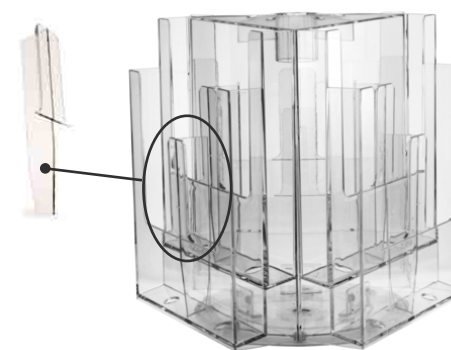

Desktop Spinners



Product code	Description	Pocket Opening Dims. (mm)	External Product Dims. (mm)
CL-RS3108	3 Pocket 1/3rd A4 Desktop Spinner	108 x 32mm	H: 210 x W: 170 x D: 170
CL-RS3152	3 Pocket A5 Desktop Spinner	152 x 32mm	H: 220 x W: 220 x D: 220
CL-RS3223	3 Pocket A4 Desktop Spinner	223 x 32mm	H: 270 x W: 285 x D: 285
CL-RS4108	4 Pocket 1/3rd A4 Desktop Spinner	108 x 32mm	H: 220 x W: 180 x D: 180
CL-RS4152	4 Pocket A5 Desktop Spinner	152 x 32mm	H: 220 x W: 230 x D: 230
CL-RS4223	4 Pocket A4 Desktop Spinner	223 x 32mm	H: 270 x W: 285 x D: 285

Product code	Image	Product code	Image
CL-RS3108		CL-RS4108	
CL-RS3152		CL-RS4152	
CL-RS3223		CL-RS4223	



Assembly

CL spinners are supplied in flat-pack form which dramatically reduces the risk of damage during transit. All components and instructions are included and assembly takes no more than a minute

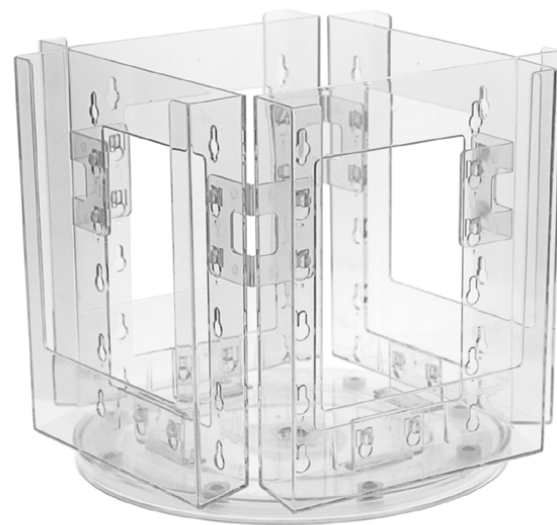
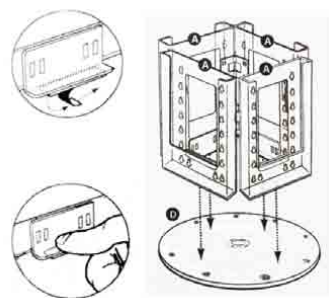
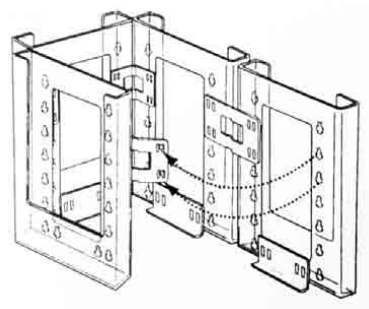

Floor Standing Carousels



Product code	Description	Pocket Sizes available	External Product Dims. (mm)
MSC2	Mix & Match Carousel - Choose Any 2 Tier Combination	DL, A5 and A4	H: 1495 x W: 615 x D: 615
CA1	Mix & Match Carousel - Choose Any 2 Tier Combination	DL, A5 and A4	H: 1495 x W: 615 x D: 615

Product code	Image
MSC2	
CA1	

Mix & Match

Choose any combination of tiers from DL, A5 and A4



Product code	Description	Pocket Opening Dims. (mm)	External Product Dims. (mm)
12F230	12 Pocket A4 Portrait Classic Carousel	230 x 32mm	H: 1495 x W: 615 x D: 615
24F230	24 Pocket A4 Portrait Classic Carousel	230 x 32mm	H: 1495 x W: 615 x D: 615

Product code	Image
12F230	
24F230	



Floor Standing Carousels



Product code	Description	Pocket Sizes available	External Product Dims. (mm)
12RC230F	12 Pocket A4 Floor Standing Carousel	A4 (dividers available to convert to DL)	H: 1495 x W: 615 x D: 615

Product code	Image
12RC230F	



CD

Removable pocket dividers. Use with **12RC230F** to convert A4 pockets to DL pockets.

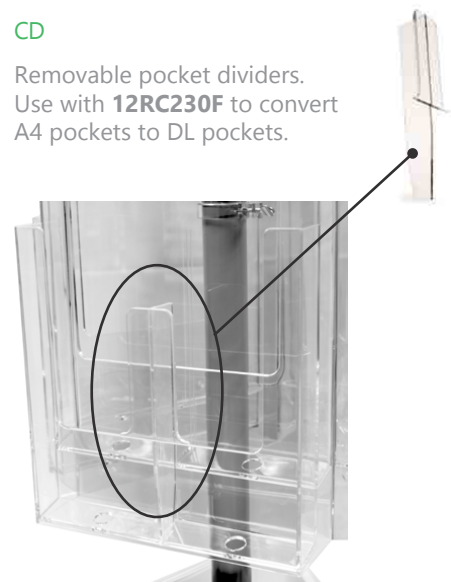

Pocket dividers can also be used with **12F230** and **24F230**

Floor Stands

- 3 & 4 Pocket Products
- 1 & 2 Pocket Products

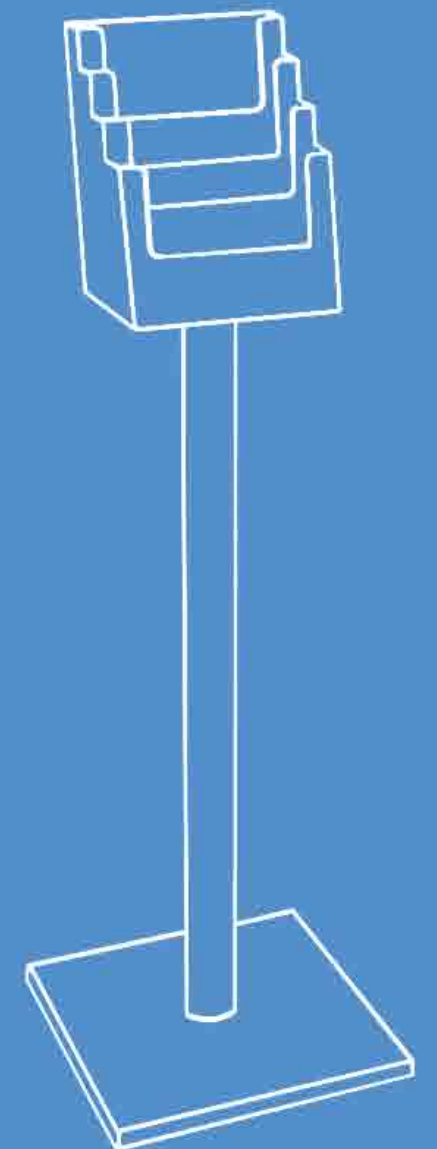

Components



Product code	Description
6RC230	Additional / replacement Tier for 12RC230F
12CA104	12 pocket 1/3rd A4 / DL tier for MSC2 & CA1
6CA160	6 pocket A5 tier for MSC2 & CA1
6CA230	6 pocket A4 tier for MSC2 & CA1
CAP210	Optional A4 header board



CAP210

Optional double sided header for floor standing carousels.

3 & 4 Pocket Floor Stands



Product code	Description	Pocket Opening Dims. (mm)	External Product Dims. (mm)
AS3104	3 Pocket 1/3rd A4 Floor Stand	104 x 32mm	H: 1050 x W: 330 x D: 330
AS3110	3 Pocket 1/3rd A4 / DL Floor Stand	110 x 32mm	H: 1080 x W: 330 x D: 330
AS3160	3 Pocket A5 Floor Stand	160 x 32mm	H: 1050 x W: 330 x D: 330
AS3230	3 Pocket A4 Floor Stand	230 x 32mm	H: 1140 x W: 330 x D: 330
AS4110	4 Pocket 1/3rd A4 / DL Floor Stand	110 x 32mm	H: 1085 x W: 330 x D: 330
AS4160	4 Pocket A5 Floor Stand	160 x 32mm	H: 1085 x W: 330 x D: 330
AS4230	4 Pocket A4 Floor Stand	230 x 32mm	H: 1140 x W: 330 x D: 330

Product code	Image
AS3104	
AS3110	
AS3160	
AS3230	

Product code	Image
AS4110	
AS4160	
AS4230	



1 & 2 Pocket Floor Stands



Product code	Description	Pocket Opening Dims. (mm)	External Product Dims. (mm)
AS330	1 Pocket A4 Landscape Floor Stand	330 x 32mm	H: 1080 x W: 330 x D: 330
ASP210	A4 Notice Holder	297 x 210mm	H: 1235 x W: 330 x D: 330
AS2155H	2 Pocket A5 Floor Stand	160 x 32mm	H: 1080 x W: 330 x D: 330

Product code	Image
AS330	
ASP210	

Product code	Image
AS2155H	

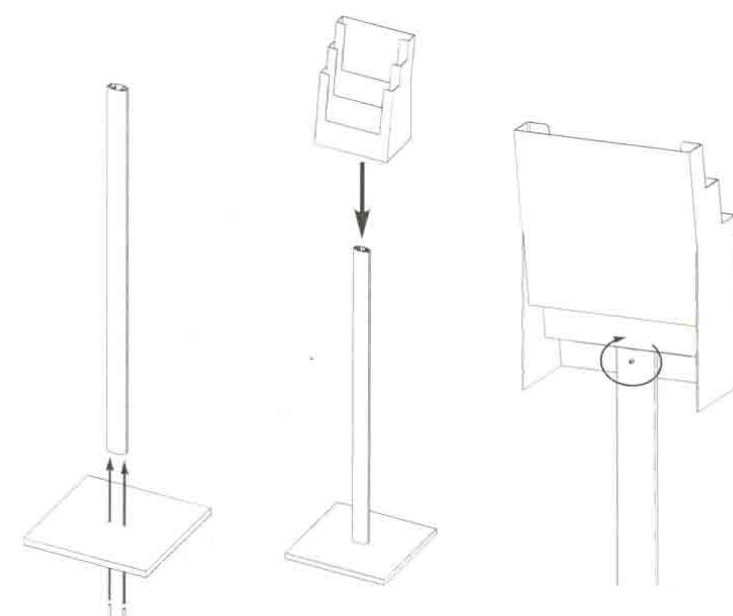

Clips & Accessories

Through clever use of simple adaptor clips, Taymar products become incredibly versatile. Easy to convert wall mounting holders for counter standing or to attached to slat-wall or to one another.

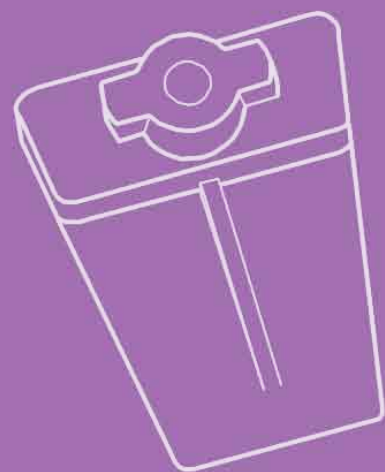

Clips & Accessories



Product code	Description
AB1	Free-standing clip for use with 4W104, W110X, W160X, W230X, WPA6X and WLA6X
CD	Pocket divider used to divide A4 portrait pockets to DL or A4 landscape to DL or A5
CLW	Clip on clips used to hang products from one another (maximum 3 products)
SWB1	Slatwall clips used to attach wall mounted products (with keyholes) to slatwall
HB1	Hanging clips used to hang wall mounted products (with keyholes) to wire frame or baskets
CL-HC	Car window hanging clips used to hang OD products and ClipLock pockets from car window
CL-SJC	Side joining clips used to connect ClipLock pockets of the same size to one another.
CL-DJC	Down joining clips used to hang ClipLock pockets to one another. Can be used for pockets of different sizes.
CL-PL-46	460mm wall rail. Used with either Taymar pockets and CLW clips or ClipLock pockets with CL-MC or CL-LC mounting clips.
CL-MC	Mounting clips used to hang ClipLock pockets to CL-PL-46 wall rail or CL-HEX brackets.
CL-LC	Leaning mounting clips used to hang ClipLock pockets to CL-PL-46 wall rail or CL-HEX brackets creating a leaning display.
CL-SMC	Surface mounting clips. Fixed to window / wall using adhesive OD products can then be mounted and removed from clip.

Product code	Image
AB1	
CD	
CLW	
SWB1	
HB1	
CL-HC	

Product code	Image
CL-SJC	
CL-DJC	
CL-PL-46	
CL-MC	
CL-LC	
CL-SMC	



Product code	Description
CL-LKB	Leaning mounting clips used to secure ClipLock pockets directly to the wall creating a leaning display
CL-VSC	Slatwall mounting clips used to hang ClipLock pockets to slatwall displays
CL-LSB	Leaning slatwall mounting clips used to hang ClipLock pockets to slatwall displays creating a leaning display
CL-SB	Supporting bracket for ClipLock wall systems. Provides support for columns of 3 or more ClipLock pockets
CL-BSC	Base securing clips. Used to provide additional support for ClipLock wall displays by fixing near the base of the display
CL-AJC	Angle joining clip. Used to secure ClipLock pockets and 6RC230 to Lazy Susan spinners
CL-CC	Coupling clips. Used to join ClipLock pockets together before bending into shape to create ClipLock desktop spinners
TSRC	Thumb screw ring clip for securing floor standing carousel components in place on the carousel pole
LS101	100mm Lazy Susan
LS145	145mm Lazy Susan
LS225	225mm Lazy Susan

Product code	Image
CL-LKB	
CL-VSC	
CL-LSB	
CL-SB	
CL-BSC	
CL-AJC	

Product code	Image
CL-CC	
TSRC	
LS101	
LS145	
LS225	

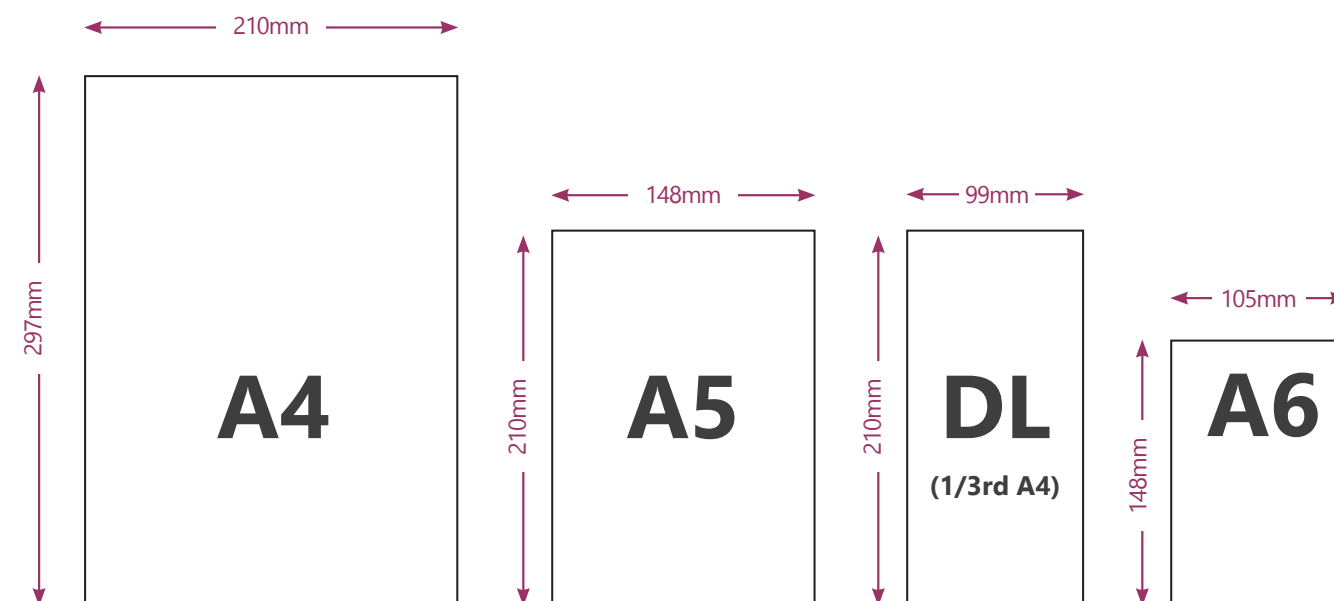

Pricing & Ordering Information



Pricing available upon request. All prices are subject to VAT at the prevailing rate. Prices are supplied on ex-works basis. All orders are subject to Brochure Holders International Ltd. terms and conditions. Prices are subject to change without prior notice. All products are available ex-stock unless otherwise stated.

Account customers:

Please email your order to sales@brochureholders.co.uk. We require an official PO or confirmation by email to process orders on account.

Non-account customers:

Goods will be available upon receipt of payment which can be made by credit/debit card, cheque or BACS transfer.

Samples:

Individual samples are available for purchase. Samples are free if we receive a purchase order within the next 30 days for the same product. It will be credited to your order. If multiple samples are ordered, we only offer credit against the actual items that are ordered, not all samples. Please note this applies to standard wall mount and counter standing items only. Carousels, floor stands and spinners are not available as samples.

If you have any questions at all please contact our sales team:

Telephone +44 (0)1473 229250

Email: sales@brochureholders.co.uk

Terms & Conditions

TERMS AND CONDITIONS FOR SALE OF GOODS OF BROCHURE HOLDERS INTERNATIONAL LTD

1 DEFINITIONS

In this document the following words shall have the following meanings:

- 1.1 "Buyer" means the organisation or person who buys Goods from the Seller;
- 1.2 "Goods" means the articles to be supplied to the Buyer by the Seller;
- 1.3 "Intellectual Property Rights" means all patents, registered and unregistered designs, copyright, trade marks, know-how and all other forms of intellectual property wherever in the world enforceable;
- 1.4 "List Price" means the list of prices of the Goods maintained by the Seller as amended from time to time;
- 1.5 "Seller" means Brochure Holders International Ltd, Unit 1, Holywells Road, Ipswich, Suffolk, IP3 0DL.

2 GENERAL

- 2.1 These Terms and Conditions shall apply to all contracts for the sale of Goods by the Seller to the Buyer to the exclusion of all other terms and conditions referred to, offered or relied on by the Buyer whether in negotiation or at any stage in the dealings between the parties, including any standard or printed terms tendered by the Buyer, unless the Buyer specifically states in writing, separately from such terms, that it wishes such terms to apply and this has been acknowledged by the Seller in writing.
- 2.2 Any variation to these Terms and Conditions (including any special terms and conditions agreed between the parties) shall be inapplicable unless agreed in writing by the Seller.

3 PRICE AND PAYMENT

- 3.1 The price shall be that in the Seller's current List Price, or such other price as the parties may agree in writing. The price is exclusive of VAT or any other applicable costs. Carriage shall be paid for by the Buyer.
- 3.2 Payment of the price and VAT (where applicable) and any other applicable costs shall be due within 30 days of the date of receipt of the invoice supplied by the Seller for UK orders, or 45 days of the date of receipt of the Goods supplied by the Seller for all international orders.
- 3.3 The Seller shall be entitled to charge interest on overdue invoices from the date when payment becomes due from 8% per annum above the base rate of the Bank of England.
- 3.4 If payment of the price or any part thereof is not made by the due date, the Seller shall be entitled to:
- 3.4.1 require payment in advance of delivery in relation to any Goods not previously delivered;
- 3.4.2 refuse to make delivery of any undelivered Goods whether ordered under the contract or not and without incurring any liability whatever to the Buyer for non-delivery or any delay in delivery;
- 3.4.3 terminate the contract.

4 DESCRIPTION

Any description given or applied to the Goods is given by way of identification only and the use of such description shall not constitute a sale by description. For the avoidance of doubt, the Buyer hereby affirms that it does not in any way rely on any description when entering into the contract.

5 SAMPLE

Where a sample of the Goods is shown to and inspected by the Buyer, the parties hereto accept that such a sample is so shown and inspected for the sole purpose of enabling the Buyer to judge for itself the quality of the bulk, and not so as to constitute a sale by sample.

Samples are available for purchase upon request. The Seller will credit the sample cost upon receipt of the Buyer's official order for the same product within 30 days. Carriage costs incurred with delivery of samples will not be credited.

6 DELIVERY

- 6.1 Unless otherwise agreed in writing, delivery of the Goods shall take place at the address specified by the Buyer on the date specified by the Seller. The Buyer shall make all arrangements necessary to take delivery of the Goods whenever they are tendered for delivery.
- 6.2 The date of delivery specified by the Seller is an estimate only. Time for delivery shall not be of the essence of the contract.
- 6.3 If the Seller is unable to deliver the Goods for reasons beyond its control, then the Seller shall be entitled to place the Goods in storage until such times as delivery may be effected and the Buyer shall be liable for any expense associated with such storage and redelivery.
- 6.4 The Buyer shall be entitled to replacement Goods where the Goods have been damaged during transportation. The Buyer must notify the Seller of the damage within 24 hours of delivery. It is the Buyer's responsibility to check that Goods are received in good condition prior to signing the carrier's delivery note.

7 RISK

Risk in the Goods shall pass to the Buyer at the moment the Goods are dispatched from the Seller's premises. Where the Buyer chooses to collect the Goods itself, risk will pass when the Goods are entrusted to it or set aside for its collection, whichever happens first.

8 TITLE

Title in the Goods shall not pass to the Buyer until the Seller has been paid in full for the Goods.

9 WARRANTY

- 9.1 Where the Goods have been manufactured by the Seller and are found to be defective, the Seller shall repair, or in its sole discretion, replace defective Goods free of charge within 30 Days from the date of delivery, subject to the following conditions:
- 9.1.1 the Buyer notifying the Seller in writing immediately upon the defect becoming apparent;
- 9.1.2 the defect being due to the faulty design, materials or workmanship of the Seller.
- 9.2 Any Goods to be repaired or replaced shall be returned to the Seller at the Buyer's expense, if so requested by the Seller.
- 9.3 Where the Goods have been manufactured and supplied to the Seller by a third party, any warranty granted to the Seller in respect of the Goods shall be passed on to the Buyer.
- 9.4 The Seller shall be entitled in its absolute discretion to refund the price of the defective Goods in the event that such price has already been paid.
- 9.5 The remedies contained in this Clause are without prejudice to the other Terms and Conditions herein, including, but without limitation, Clauses 10 and 11 below.

10 LIABILITY

- 10.1 No liability of any nature shall be incurred or accepted by the Seller in respect of any representation made by the Seller, or on its behalf, to the Buyer, or to any party acting on its behalf, prior to the making of this contract where such representations were made or given in relation to:
- 10.1.1 the correspondence of the Goods with any description;
- 10.1.2 the quality of the Goods; or
- 10.1.3 the fitness of the Goods for any purpose whatsoever.
- 10.2 No liability of any nature shall be accepted by the Seller to the Buyer in respect of any express term of this contract where such term relates in any way to:
- 10.2.1 the correspondence of the Goods with any description;



Screen Printing & Vinyl Labels



Add that little bit extra to your display!

Personalise holders with your company logo, a message or advertising slogan. We can offer you a customised printing service to apply your message, slogan or logo directly onto the brochure/information holder of your choice.

The service includes Screen Printing or Vinyl Labels, both of which are fantastic ways to personalise Taymar products and achieve fantastic results.

Printing Areas

The following pages show the maximum screen printing area of each product in the Taymar range. In most cases, vinyl labels have slightly more flexibility and can also be applied to the sides of units as well.

Requirements

We are PC based. MAC files should be saved in PC format. Most common design and graphics programmes are supported. All fonts must be converted to curves, paths or outlines (Vector files). This avoids font matching and resolution problems and enables us to apply trapping or to make modifications to suit screen process print.

EPS & TIF Files: TIF files must be provided to highest possible resolution and should be at least 1200dpi. For line work all colours should be set as Pantone spot colours and not as CMYK.

Portable Document Files (PDF): PDF files are supported and all fonts must be converted to curves etc as above.

GIF – JPEG – BMP & Word files: GIF - JPEG - BMP and Word files are not acceptable for use as artwork. These files are normally not suitable for reproduction.

Camera ready Artwork: Camera ready artwork can be accepted but this will be scanned and converted to an electronic file.

Brochure Holder & Leaflet Holder Artwork Preparation

It is preferable to supply line artwork for these products but this does not rule out halftone or four colour process work provided the design allows for any screen resolution restrictions. We suggest that any tints are between 30% and 70%.

It is advisable to check the compatibility of your programmes with us before dispatching artwork. However, provided it is supplied as a vector file with all fonts converted to outlines there should not be a problem. Please ensure a proof is supplied showing any special instructions. Artwork should be adapted to suit screen process printing. Colour separations, trapping, order of printing colours can be significantly different to lithographic printing.

Brochure Holders & Colour Matching

Certain colours may appear slightly transparent when printed on to clear products. This is due to the pigments used in the manufacture of the inks. In many cases a background colour, such as White, will have to be printed.

Colour Matching

We use the Pantone reference system. If a reference colour is not available then a suitable swatch should be supplied. Adjustments have to be made to suit the substrate.

- 10.2.2 the quality of the Goods; or
- 10.2.3 the fitness of the Goods for any purpose whatsoever.
- 10.3 All implied terms, conditions or warranties as to the correspondence of the Goods to any description or the satisfactory quality of the Goods or the fitness of the Goods for any purpose whatsoever (whether made known to the Seller or not) are hereby excluded from the contract.
- 11 LIMITATION OF LIABILITY**
- 11.1 Where any court or arbitrator determines that any part of Clause 10 above is, for whatever reason, unenforceable, the Seller shall be liable for all loss or damage suffered by the Buyer but in an amount not exceeding the contract price.
- 11.2 Nothing contained in these Terms and Conditions shall be construed so as to limit or exclude the liability of the Seller for death or personal injury as a result of the Seller's negligence or that of its employees or agents.
- 12 INTELLECTUAL PROPERTY RIGHTS**
- All Intellectual Property Rights produced from or arising as a result of the performance of this Agreement shall, so far as not already vested, become the absolute property of the Seller, and the Buyer shall do all that is reasonably necessary to ensure that such rights vest in the Seller by the execution of appropriate instruments or the making of agreements with third parties.
- 13 FORCE MAJEURE**
- The Seller shall not be liable for any delay or failure to perform any of its obligations if the delay or failure results from events or circumstances outside its reasonable control, including but not limited to acts of God, strikes, lock outs, accidents, war, fire, breakdown of plant or machinery or shortage or unavailability of raw materials from a natural source of supply, and the Seller shall be entitled to a reasonable extension of its obligations. If the delay persists for such time as the Seller considers unreasonable, it may, without liability on its part, terminate the contract.
- 14 RELATIONSHIP OF PARTIES**
- Nothing contained in these Terms and Conditions shall be construed as establishing or implying any partnership or joint venture between the parties and nothing in these Terms and Conditions shall be deemed to construe either of the parties as the agent of the other.
- 15 ASSIGNMENT AND SUB-CONTRACTING**
- The contract between the Buyer and Seller for the sale of Goods shall not be assigned or transferred, nor the performance of any obligation sub-contracted, in either case by the Buyer, without the prior written consent of the Seller.
- 16 WAIVER**
- The failure by either party to enforce at any time or for any period any one or more of the Terms and Conditions herein shall not be a waiver of them or of the right at any time subsequently to enforce all Terms and Conditions of this Agreement.
- 17 SEVERABILITY**
- If any term or provision of these Terms and Conditions is held invalid, illegal or unenforceable for any reason by any court of competent jurisdiction such provision shall be severed and the remainder of the provisions hereof shall continue in full force and effect as if these Terms and Conditions had been agreed with the invalid, illegal or unenforceable provision eliminated.
- 18 GOVERNING LAW AND JURISDICTION**
- This Agreement shall be governed by and construed in accordance with the law of England and the parties hereby submit to the exclusive jurisdiction of the English courts.

Product Index



Product code	Page No.	Product code	Page No.	Product code	Page No.	Product code	Page No.
12C230	27	AS3104	32	CL-LC	35	SWB1	35
12CA104	30	AS2155	33	CL-LKB	36	TS110	15
12F230	29	AS3104	32	CL-LSB	36	TS160	15
12RC230F	30	AS3110H	32	CL-MC	35	TS230	15
24F230	29	AS3160	32	CL-PL-46	35	V100/B	19
2C110	04	AS3230	32	CL-RS3108	28	V150/B	19
2C112	04	AS330	33	CL-RS3152	28	V210/B	19
2C155H	04	AS4110	32	CL-RS3223	28	VBC56	17
2C160	04	AS4160	32	CL-RS4108	28	W110	02
2C230	4/7	AS4230	32	CL-RS4152	28	W110X	09
2C230X	04	ASP210	33	CL-RS4223	28	W160	02
2CA6	04	BC93	17	CL-SB	36	W160X	09
2W155H	11	C110	02	CL-SJC	35	W230	02
2WA6	11	C160	02	CL-SMC	35	W230X	09
3C104	05	C230	02	CL-VSC	36	W330	10
3C110H	05	C330	03	CL230	03	WL230	10
3C230	05	CA1	29	CLA5	03	WLA5	10
3W110H	11	CAP210	30	CLW	36	WLA6	03
3W230	11	CD	35	CWBC93	17	WLA6X	10
4BC93	17	CL-108	09	FP110	03	WPA6	02
4C110	06	CL-152	09	HB1	36	WPA6X	09
4C160	06	CL-223	09	L100/B	21	WS16-D8	12
4C230	6/7	CL-AJC	36	L150/B	21		
4C230X	06	CL-BSC	36	L210/B	21		
4C330	6/7	CL-CC	36	M120/B	20		
4C330X	06	CL-DJC	35	M160/B	20		
4W104	6/11	CL-HC	35	M210/B	20		
6CA160	30	CL-KIT1	12	MSC2	29		
6CA230	30	CL-KIT2	12	NB93	17		
6RC230	30	CL-KIT3	12	NH210	23		
6RC230C	27	CL-KIT4	12	OD110	25		
8BC93	17	CL-KIT5	12	OD160	25		
AB1	35	CL-KIT6	12	OD230	25		
AP150	22	CL-KIT7	12	OD95	25		
AP210	22			PC260	23		

Brochure Holders

International Ltd



Brochure Holders International Ltd
Unit 1 Holywells Road, Ipswich, Suffolk
IP3 0DL United Kingdom

Tel: +44 (0)1473 229250

Email: sales@brochureholders.co.uk

Web: www.brochureholders.co.uk



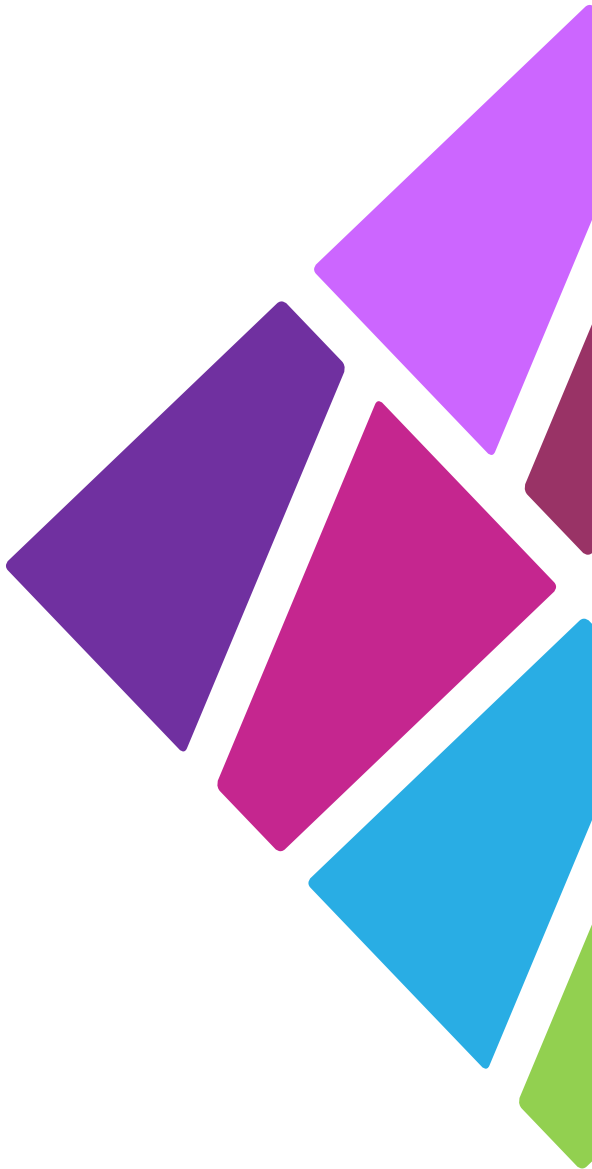

Brochure Holders International Ltd

Unit 1 Holywells Road, Ipswich, Suffolk
IP3 0DL United Kingdom

Tel: +44 (0)1473 229250

Email: sales@brochureholders.co.uk

Web: www.brochureholders.co.uk

