



Clearly the best

Premium quality, UK manufactured leaflet dispensers

Brochure Holders International

We are delighted to present the new catalogue which has been designed as a reference tool for the items in our Taymar range.

Detailed product information can also be found on our website www.brochureholders.com. Pricing is available separately.

Brochure Holders International Limited is part of the global Taymar group recognised as a world leading manufacturer of premium quality injection moulded leaflet holders/brochure display units. The corporation has built an industry wide reputation for deliverable quality with its 'Taymar' brand which is founded on three fundamental commercial tenets: Service, quality and competitive pricing.

Trading began in the early Eighties and the group has been a driving force in helping world commerce better present its products and services at the point of sale and purchase. We offer one of the worlds largest ranges of 'crystal clear' wall, floor and counter standing brochure display options. Our aim is to provide European businesses with a classic point of sale solution to help them sell more.

Corporate Strategy

The entire range of recyclable Taymar products is manufactured to the highest quality control standards. We aim to add new products to our range each year and continue to invest heavily in research and development. Latest state of the art, robot-driven, multi-cavity injection moulding machines enables the company to maintain both quality control targets and a keenly competitive pricing strategy.

Our sales are primarily channelled through an extensive range of wholesalers and distributors.

Comprehensive stock availability is key to our corporate strategy and our location, which is close to ports, airports and major road links, allows us to fulfil a market-leading 99% of all orders within 24 - 48 hours.

Our success has been underscored with first class support for our key distributor network. With the help of our expert in-house team we can provide our customers with rapid order fulfilment across every European territory.

Contact & Advice

We have considerable combined experience in the world of brochure holders and the injection moulding process. If you are interested in representing or stocking our products or if you are an existing distributors wishing to increase product range offered our team of knowledgeable staff are on hand to assist with your requirements and technical queries.

Tel: +44 (0)1473 229250

Email: sales@brochureholders.co.uk

Fax: +44 (0)1473 229251



Contents

1. Counter Stands

1/3rd A4/DL (trifold) Brochure Holders | A4 Brochure Holders | A5 Brochure Holders | A6 Brochure Holders

2. Wall Mounting

1/3rd A4/DL (trifold) Brochure Holders | A4 Brochure Holders | A5 Brochure Holders | A6 Brochure Holders

3. Business Card

4. Single Page

Base only | Complete with PVC cover

5. Outdoor Leaflet Holders

Business Card | 1/3rd A4/DL (trifold) Brochure Holders | A4 Brochure Holders | A5 Brochure Holders

6. Floor Standing Carousels

7. Desktop Spinners - Taymar

8. Desktop Spinners - ClipLock

9. Floor Stands

Luxury Floor Stands | Floor Stands

10. Wall System

11. Accessories & Parts

Clips | Other Accessories | Stands & Bases

12. Screen Printing

1. Counter Stands

A comprehensive range of counter standing brochure holders designed to suit all popular paper sizes. Multi-tier and multi-pocket versions available.

Visit www.brochureholders.com for further details.

1/3rd A4 / DL

SIZE: 1/3rd A4/DL



CL230
1 pocket 1/3rd A4/DL landscape leaflet holder
Carton quantity 48
Opening dimensions: **230 x 32mm**
Crystal Clear Polystyrene

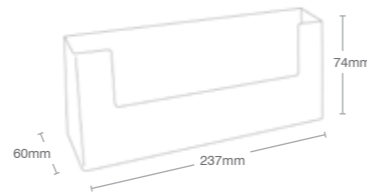

SIZE: 1/3rd A4/DL



C110
1 pocket 1/3rd A4/DL portrait leaflet holder
Carton quantity 80
Opening dimensions: **110 x 32mm**
Crystal Clear Polystyrene



SIZE: 1/3rd A4/DL



FP110
1 pocket 1/3rd A4/DL flat pack leaflet holder
Carton quantity 100
Opening dimensions: **110 x 32mm**
Polypropylene

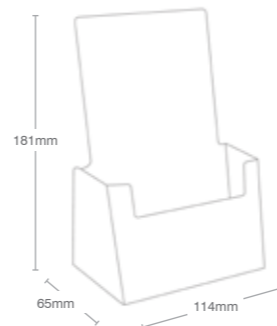

SIZE: 1/3rd A4/DL



TS110
1 pocket 1/3rd A4/DL portrait leaflet holder
Carton quantity 40
Pocket is open-ended and can accommodate oversized 1/3rd A4/DL leaflets. Pocket depth: 32mm
Crystal Clear Polystyrene

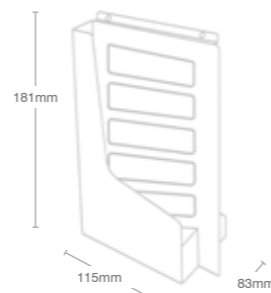

SIZE: 1/3rd A4/DL



W110 - with removable AB1 counter stand clip
1 pocket 1/3rd A4/DL portrait leaflet holder
Carton quantity 100
Opening dimensions: **110 x 32mm**
Crystal Clear Polystyrene

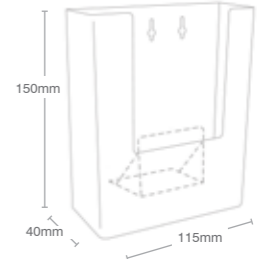

SIZE: 1/3rd A4/DL



2C110
2 pocket 1/3rd A4/DL portrait leaflet holder
Carton quantity 32
Opening dimensions: **110 x 32mm**
Crystal Clear Polystyrene

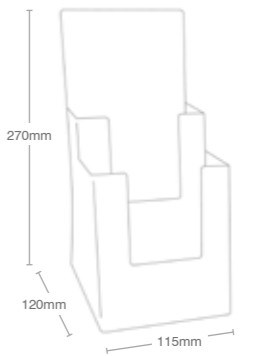

SIZE: 1/3rd A4/DL



2C112
2 pocket 1/3rd A4/DL portrait leaflet holder
Carton quantity 36
Opening dimensions: **112 x 32mm**

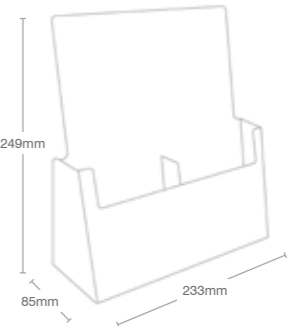

SIZE: 1/3rd A4



3C104
3 pocket 1/3rd A4 portrait leaflet holder
Carton quantity 20
Opening dimensions: **104 x 32mm**
Crystal Clear Polystyrene

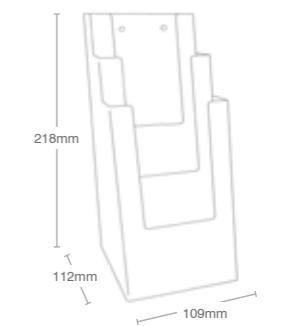

SIZE: 1/3rd A4/DL



3C110H
3 pocket 1/3rd A4/DL portrait leaflet holder
Carton quantity 24
Opening dimensions: **110 x 32mm**
Crystal Clear Polystyrene

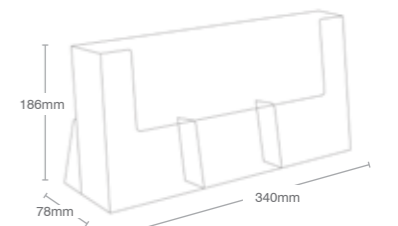

SIZE: 1/3rd A4



4W104 - with removable AB1 counter stand clip
4 pocket 1/3rd A4 portrait leaflet holder
 Carton quantity 24
 Opening dimensions: **104 x 32mm**
 Crystal Clear Polystyrene

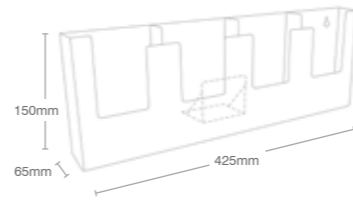

SIZE: 1/3rd A4/DL



4C110
4 pocket 1/3rd A4/DL portrait leaflet holder
 Carton quantity 20
 Opening dimensions: **110 x 32mm**
 Crystal Clear Polystyrene

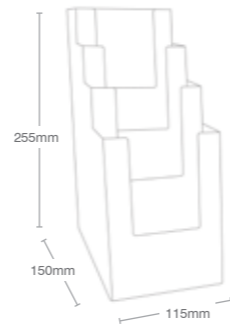

SIZE: 1/3rd A4/DL



2C230 - supplied with 2 removable CD pocket dividers
4 pocket 1/3rd A4/DL portrait leaflet holder
 Carton quantity 16
 Opening dimensions: **110 x 32mm**
 Crystal Clear Polystyrene

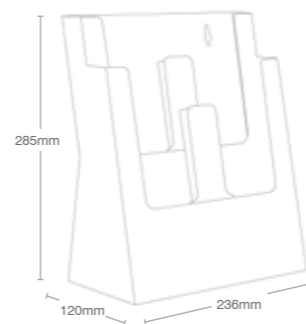

SIZE: 1/3rd A4/DL



4C230 - supplied with 4 removable CD pocket dividers
8 pocket 1/3rd A4/DL portrait leaflet holder
 Carton quantity 8
 Opening dimensions: **110 x 32mm**
 Crystal Clear Polystyrene

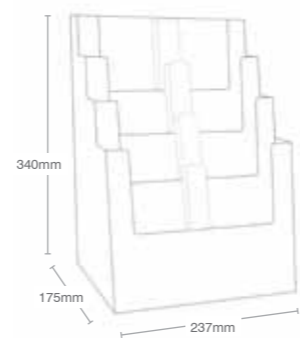

SIZE: 1/3rd A4/DL



4C330 - supplied with 8 removable CD pocket dividers
12 pocket 1/3rd A4/DL portrait leaflet holder
 Carton quantity 8
 Opening dimensions: **110 x 32mm**
 Crystal Clear Polystyrene

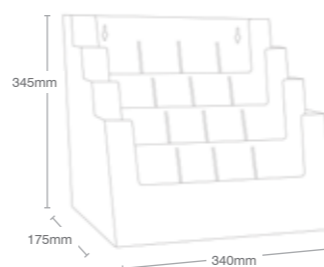

A4

SIZE: A4



C330
1 pocket A4 landscape leaflet holder
 Carton quantity 24
 Opening dimensions: **330 x 32mm**
 Crystal Clear Polystyrene

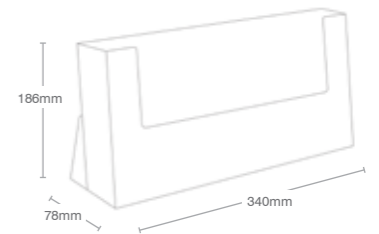

SIZE: A4



C230
1 pocket A4 portrait leaflet holder
 Carton quantity 36
 Opening dimensions: **230 x 32mm**
 Crystal Clear Polystyrene

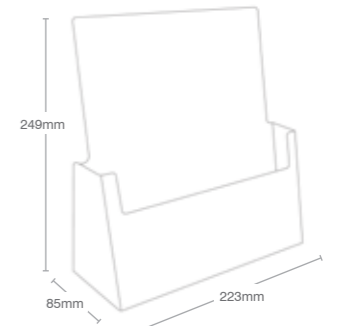

SIZE: A4



TS230
1 pocket A4 portrait leaflet holder
 Carton quantity 32
 Pocket is open-ended and can accommodate oversized A4 leaflets. Pocket depth: 32mm
 Crystal Clear Polystyrene

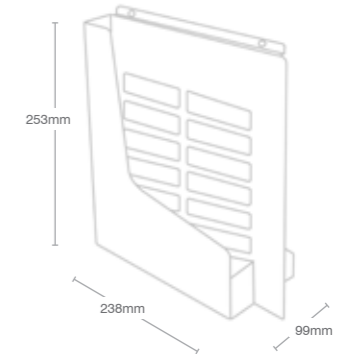

SIZE: A4



W230 - with removable AB1 counter stand clip
1 pocket A4 portrait leaflet holder
 Carton quantity 44
 Opening dimensions: **230 x 32mm**
 Crystal Clear Polystyrene

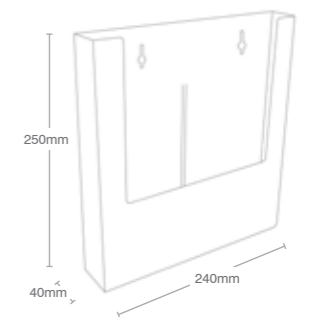

SIZE: A4



2C230X
2 pocket A4 portrait leaflet holder
 Carton quantity 16
 Opening dimensions: **230 x 32mm**
 Crystal Clear Polystyrene

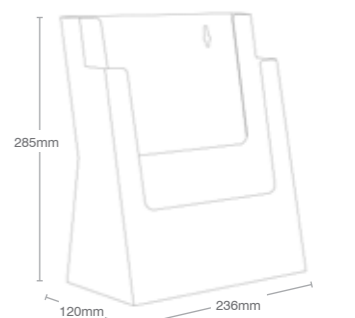

SIZE: A4



2C230 - supplied with 2 removable CD pocket dividers
2 pocket A4 portrait leaflet holder
 Carton quantity 16
 Opening dimensions: **230 x 32mm**
 Crystal Clear Polystyrene

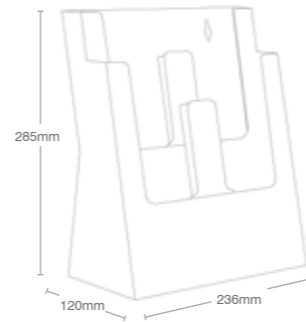

SIZE: A4



4C330 - supplied with 8 removable CD pocket dividers
4 pocket A4 leaflet holder
 Carton quantity 8
 Opening dimensions: **330 x 32mm**
 Crystal Clear Polystyrene

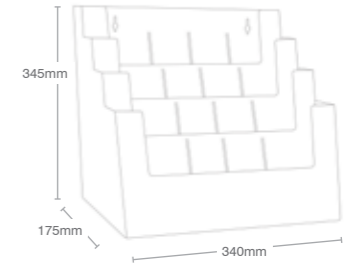

SIZE: A4



3C230
3 pocket A4 portrait leaflet holder
 Carton quantity 12
 Opening dimensions: **230 x 32mm**
 Crystal Clear Polystyrene

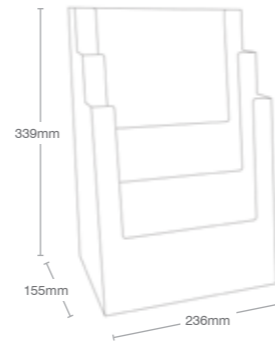

SIZE: A5

A5



CLA5
1 pocket A5 landscape leaflet holder
 Carton quantity 48
 Opening dimensions: **230 x 32mm**
 Crystal Clear Polystyrene

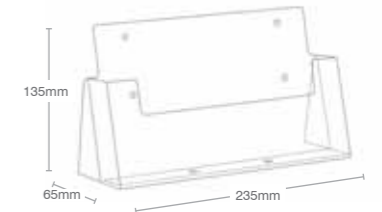

SIZE: A4



4C230X
4 pocket A4 portrait leaflet holder
 Carton quantity 8
 Opening dimensions: **230 x 32mm**
 Crystal Clear Polystyrene

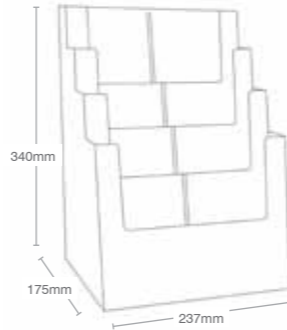

SIZE: A5



C160
1 pocket A5 portrait leaflet holder
 Carton quantity 80
 Opening dimensions: **160 x 32mm**
 Crystal Clear Polystyrene

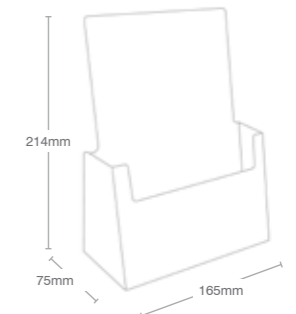

SIZE: A4



4C230 - supplied with 4 removable CD pocket dividers
4 pocket A4 portrait leaflet holder
 Carton quantity 8
 Opening dimensions: **230 x 32mm**
 Crystal Clear Polystyrene

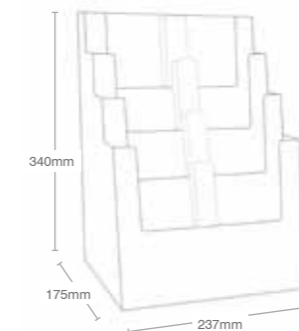

SIZE: A5



W160 - with removable AB1 counter stand clip
1 pocket A5 portrait leaflet holder
 Carton quantity 88
 Opening dimensions: **160 x 32mm**
 Crystal Clear Polystyrene

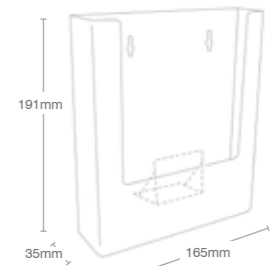

SIZE: A4



4C330X
4 pocket A4 landscape leaflet holder
 Carton quantity 8
 Opening dimensions: **330 x 32mm**
 Crystal Clear Polystyrene

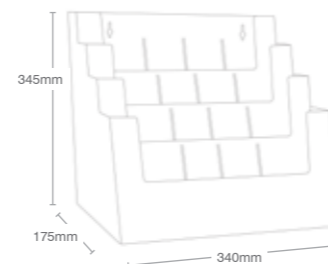

SIZE: A5



2C155H
2 pocket A5 portrait leaflet holder
 Carton quantity 24
 Opening dimensions: **160 x 32mm**
 Crystal Clear Polystyrene

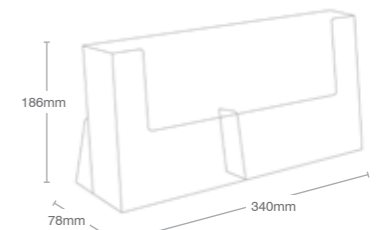

SIZE: A5



2C160
2 pocket A5 portrait leaflet holder
 Carton quantity 24
 Opening dimensions: **160 x 48mm**
 Crystal Clear Polystyrene



SIZE: A5



3C160
3 pocket A5 portrait leaflet holder
 Carton quantity 18
 Opening dimensions: **160 x 32mm**
 Crystal Clear Polystyrene

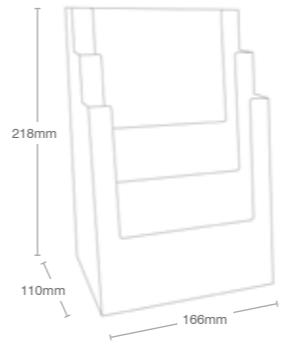

SIZE: A5



4C160
4 pocket A5 portrait leaflet holder
 Carton quantity 18
 Opening dimensions: **160 x 32mm**
 Crystal Clear Polystyrene

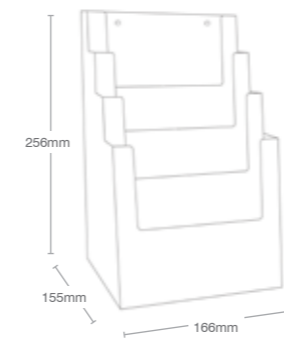

SIZE: A5



4C330 - supplied with 8 removable CD pocket dividers
8 pocket A5 portrait leaflet holder
 Carton quantity 8
 Opening dimensions: **160 x 32mm**
 Crystal Clear Polystyrene

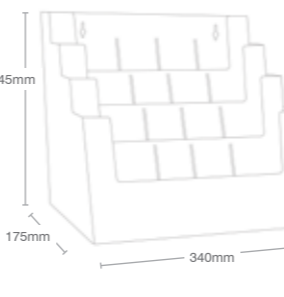

SIZE: A5



TS160
1 pocket A5 portrait leaflet holder
 Carton quantity 40
 Pocket is open-ended and can accommodate oversized A5 leaflets. Pocket depth: 32mm
 Crystal Clear Polystyrene

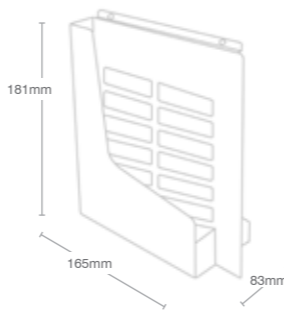

A6

SIZE: A6



WLA6 - with removable AB1 counter stand clip
1 pocket A6 landscape leaflet holder
 Carton quantity 56
 Opening dimensions: **160 x 32mm**
 Crystal Clear Polystyrene

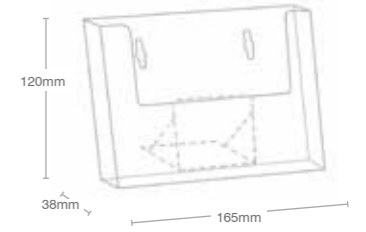

SIZE: A6



WPA6 - with removable AB1 counter stand clip
1 pocket A6 portrait leaflet holder
 Carton quantity 80
 Opening dimensions: **110 x 32mm**
 Crystal Clear Polystyrene

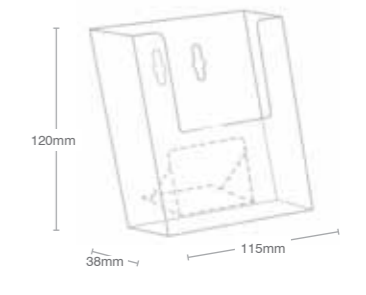

SIZE: A6



2CA6
2 pocket A6 portrait leaflet holder
 Carton quantity 48
 Opening dimensions: **112 x 32mm**
 Crystal Clear Polystyrene

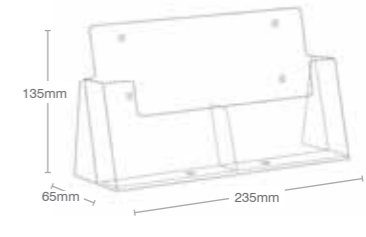

2. Wall Mounting

Products to suit 1/3rd A4/DL, A5 & A4 literature for wall mounting display. Most of these products are also suitable for attaching to slat-wall and wire displays by using simple Taymar adaptor clips. Look also for the leaflet dispensers that are dual purpose wall mounting and counter standing.

Visit www.brochureholders.com

1/3rd A4 / DL

SIZE: 1/3rd A4/DL



WL230

1 pocket 1/3rd A4/DL landscape leaflet holder

Carton quantity 84
Opening dimensions: **230 x 32mm**
Crystal Clear Polystyrene

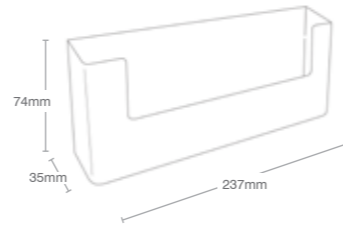

SIZE: 1/3rd A4/DL



TS110

1 pocket 1/3rd A4/DL portrait leaflet holder

Carton quantity 40
Pocket is open-ended and can accommodate oversized 1/3rd A4/DL leaflets. Pocket depth: 32mm
Crystal Clear Polystyrene

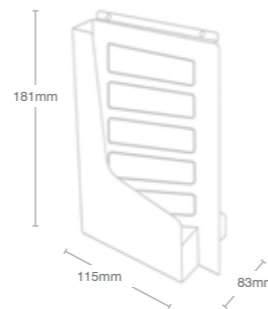

SIZE: 1/3rd A4/DL



FP110

1 pocket 1/3rd A4/DL flat pack leaflet holder

Carton quantity 100
Opening dimensions: **110 x 32mm**
Polypropylene

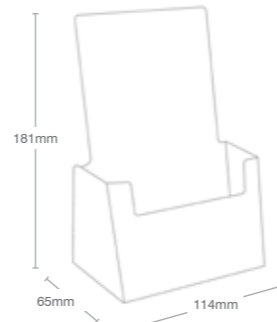

SIZE: 1/3rd A4/DL



W110X

1 pocket 1/3rd A4/DL portrait leaflet holder

Carton quantity 100
Opening dimensions: **110 x 32mm**
Crystal Clear Polystyrene

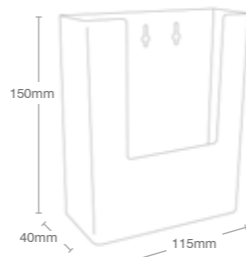

SIZE: 1/3rd A4



3C104

3 pocket 1/3rd A4 portrait leaflet holder

Carton quantity 20
Opening dimensions: **104 x 32mm**
Crystal Clear Polystyrene

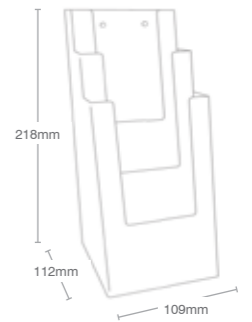

SIZE: 1/3rd A4/DL



3W110H

3 pocket 1/3rd A4/DL portrait leaflet holder

Carton quantity 36
Opening dimensions: **110 x 32mm**
Crystal Clear Polystyrene

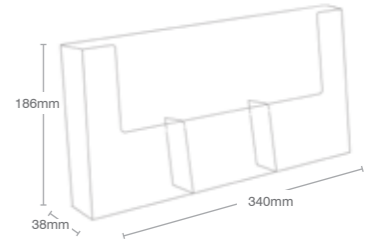

SIZE: 1/3rd A4



4W104

4 pocket 1/3rd A4 portrait leaflet holder

Carton quantity 24
Opening dimensions: **104 x 32mm**
Crystal Clear Polystyrene

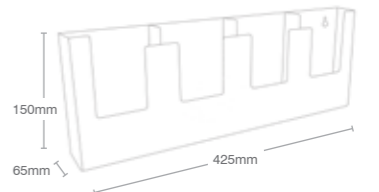

SIZE: 1/3rd A4/DL



2C230 - supplied with 2 removable CD pocket dividers

4 pocket 1/3rd A4/DL portrait leaflet holder

Carton quantity 16
Opening dimensions: **110 x 32mm**
Crystal Clear Polystyrene

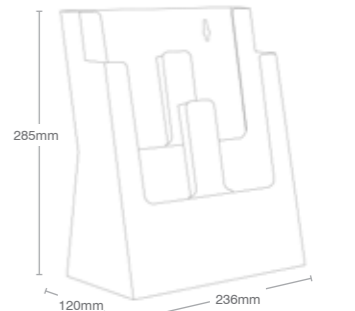

SIZE: 1/3rd A4/DL



4C230 - supplied with 4 removable CD pocket dividers

8 pocket 1/3rd A4/DL portrait leaflet holder

Carton quantity 8
Opening dimensions: **110 x 32mm**
Crystal Clear Polystyrene

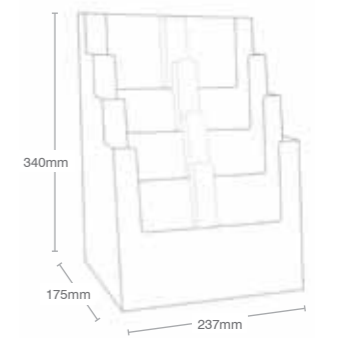

SIZE: 1/3rd A4/DL



4C330 - supplied with 8 removable CD pocket dividers
12 pocket 1/3rd A4/DL portrait leaflet holder
 Carton quantity 8
 Opening dimensions: **110 x 32mm**
 Crystal Clear Polystyrene

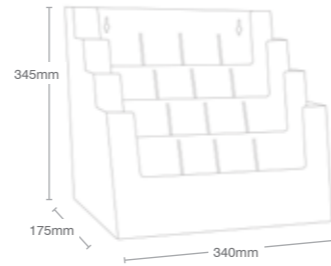

SIZE: A4



2C230X
2 pocket A4 portrait leaflet holder
 Carton quantity 16
 Opening dimensions: **230 x 32mm**
 Crystal Clear Polystyrene

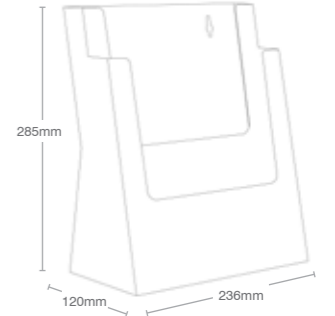

A4

SIZE: A4



W330
1 pocket A4 landscape leaflet holder
 Carton quantity 36
 Opening dimensions: **330 x 32mm**
 Crystal Clear Polystyrene

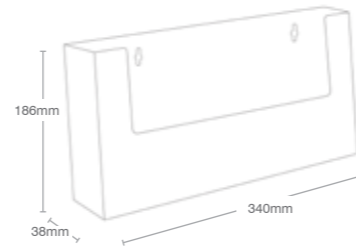

SIZE: A4



4C330X
4 pocket A4 landscape leaflet holder
 Carton quantity 8
 Opening dimensions: **330 x 32mm**
 Crystal Clear Polystyrene

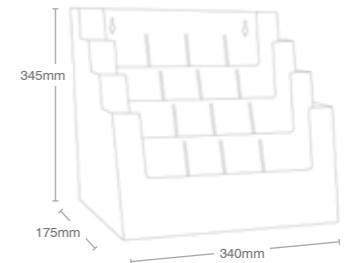

SIZE: A4



W230X
1 pocket A4 portrait leaflet holder
 Carton quantity 44
 Opening dimensions: **230 x 32mm**
 Crystal Clear Polystyrene

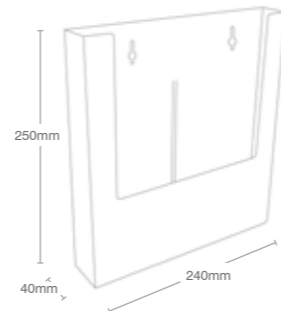

SIZE: A4



4C230 - supplied with 4 removable CD pocket dividers
4 pocket A4 portrait leaflet holder
 Carton quantity 8
 Opening dimensions: **230 x 32mm**
 Crystal Clear Polystyrene

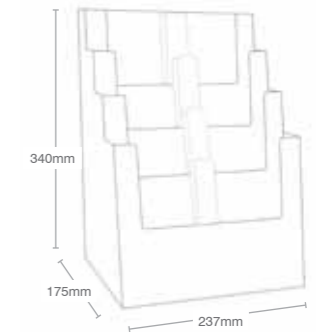

SIZE: A4



TS230
1 pocket A4 portrait leaflet holder
 Carton quantity 32
 Pocket is open-ended and can accommodate oversized A4 leaflets. Pocket depth: 32mm
 Crystal Clear Polystyrene

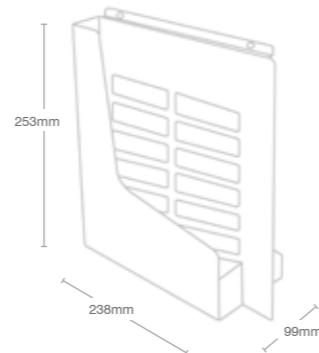

SIZE: A4



4C230X
4 pocket A4 portrait leaflet holder
 Carton quantity 8
 Opening dimensions: **230 x 32mm**
 Crystal Clear Polystyrene

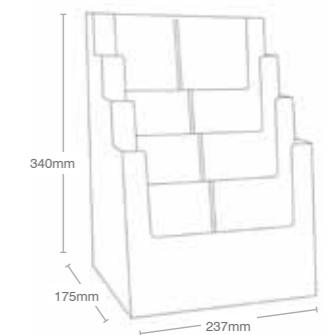

SIZE: A4



3W230
3 pocket A4 portrait leaflet holder
 Carton quantity 12
 Opening dimensions: **230 x 32mm**
 Crystal Clear Polystyrene

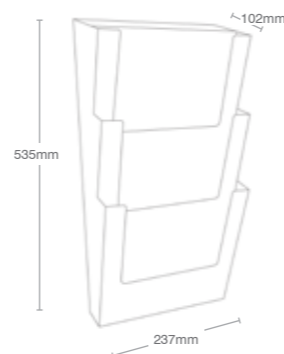

SIZE: A5

A5



WLA5
1 pocket A5 landscape leaflet holder
 Carton quantity 84
 Opening dimensions: **230 x 32mm**
 Crystal Clear Polystyrene

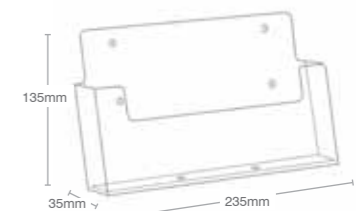

SIZE: A5



TS160

1 pocket A5 portrait leaflet holder

Carton quantity 40
Pocket is open-ended and can accommodate oversized A5 leaflets. Pocket depth: 32mm
Crystal Clear Polystyrene

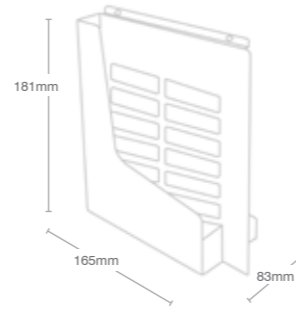

SIZE: A5



2W155H

2 pocket A5 portrait leaflet holder

Carton quantity 36
Opening dimensions: **160 x 32mm**
Crystal Clear Polystyrene

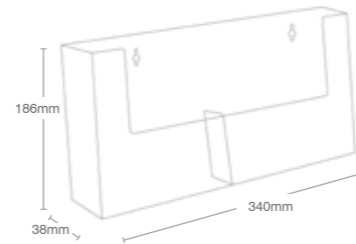

SIZE: A5



W160X

1 pocket A5 portrait leaflet holder

Carton quantity 88
Opening dimensions: **160 x 32mm**
Crystal Clear Polystyrene

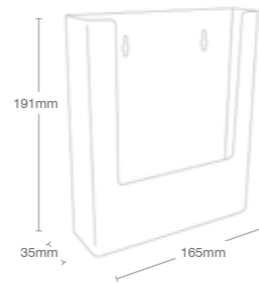

SIZE: A5



2C160

2 pocket A5 portrait leaflet holder

Carton quantity 24
Opening dimensions: **160 x 48mm**
Crystal Clear Polystyrene

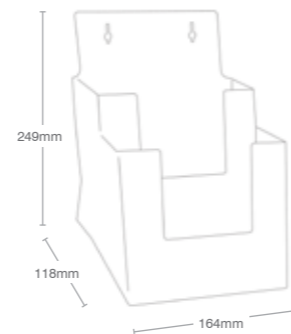

SIZE: A5



3C160

3 pocket A5 portrait leaflet holder

Carton quantity 18
Opening dimensions: **160 x 32mm**
Crystal Clear Polystyrene

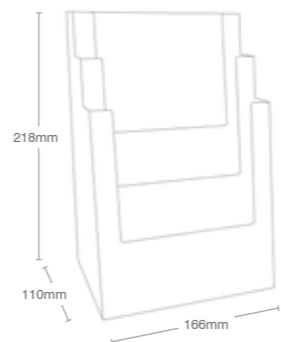

SIZE: A5



4C160

4 pocket A5 portrait leaflet holder

Carton quantity 18
Opening dimensions: **160 x 32mm**
Crystal Clear Polystyrene

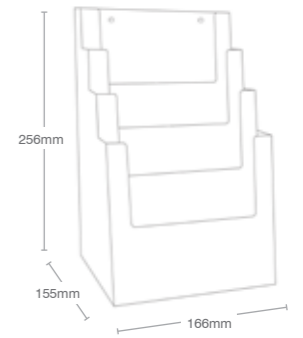

SIZE: A5



4C330 - supplied with 8 removable CD pocket dividers

8 pocket A5 portrait leaflet holder

Carton quantity 8
Opening dimensions: **330 x 32mm**
Crystal Clear Polystyrene

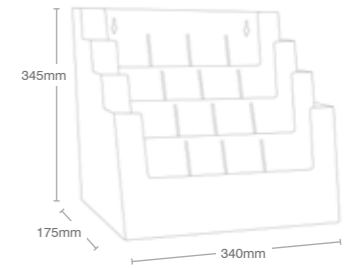

SIZE: A6

A6



WLA6X

1 pocket A6 landscape leaflet holder

Carton quantity 56
Opening dimensions: **160 x 32mm**
Crystal Clear Polystyrene

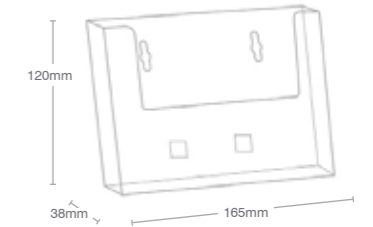

SIZE: A6



WPA6X

1 pocket A6 portrait leaflet holder

Carton quantity 80
Opening dimensions: **110 x 32mm**
Crystal Clear Polystyrene

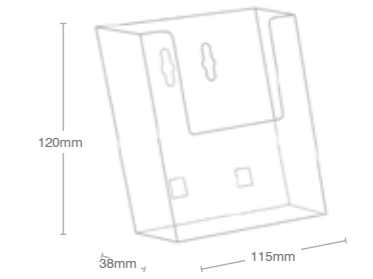

SIZE: A6



2WA6

2 pocket A6 portrait leaflet holder

Carton quantity 84
Opening dimensions: **112 x 32mm**
Crystal Clear Polystyrene

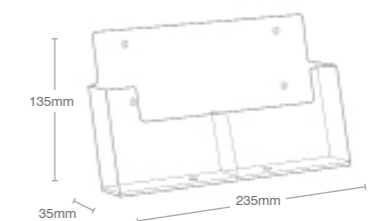

3. Business Card Holders

Taymar business card holders are offered in both landscape and portrait styles. As well as the ever popular single pocket version, both four and eight pocket versions are offered. Use the flat back or clip-on alternatives to attach to other products for maximum effect.

Visit www.brochureholders.com

BUSINESS CARD HOLDERS

Business Card Holders



BC93

1 pocket landscape business card holder
- counter standing

Carton quantity 250
Opening dimensions: **93 x 18mm**
Crystal Clear Polystyrene

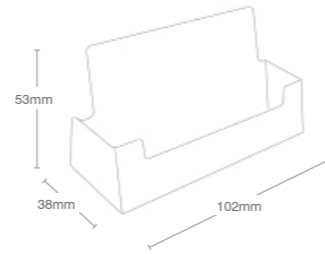

Business Card Holders



WBC93

1 pocket landscape business card holder
- wall mounting

Carton quantity 250
Opening dimensions: **93 x 18mm**
Crystal Clear Polystyrene

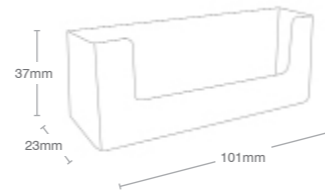

Business Card Holders



CWBC93

1 pocket landscape clip-on business card holder

Carton quantity 250
Opening dimensions: **93 x 18mm**
Crystal Clear Polystyrene

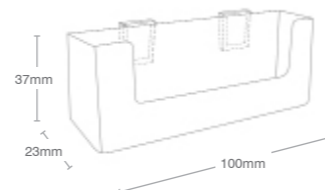

Business Card Holders



NB93

1 pocket landscape business card holder
- backless

Carton quantity 130
Opening dimensions: **93 x 18mm**
Crystal Clear Polystyrene

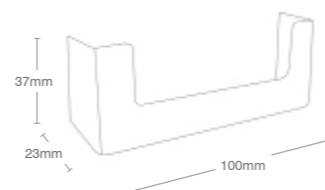

Business Card Holders



VBC56

1 pocket portrait business card holder
- counter standing

Carton quantity 280
Opening dimensions: **59 x 19mm**
Crystal Clear Polystyrene

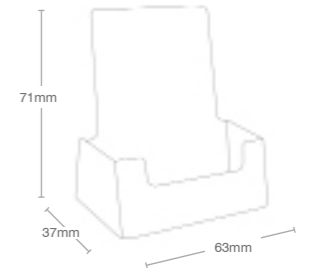

Business Card Holders



4BC93

4 pocket landscape business card holder
- counter standing

Carton quantity 72
Opening dimensions: **93 x 18mm**
Crystal Clear Polystyrene

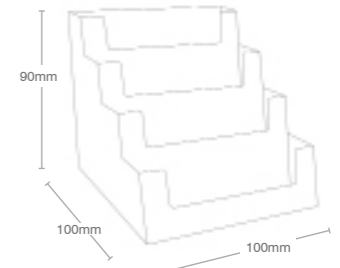

Business Card Holders



8BC93

8 pocket landscape business card holder
- counter standing

Carton quantity 36
Opening dimensions: **93 x 18mm**
Crystal Clear Polystyrene

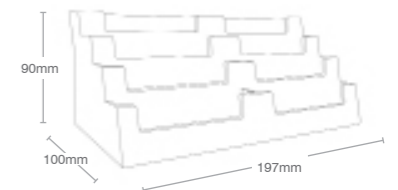

Business Card Holders



OD95

1 pocket landscape outdoor business card holder
- wall mounting

Carton quantity 40
Opening dimensions: **95 x 25mm**
Crystal Clear Polystyrene

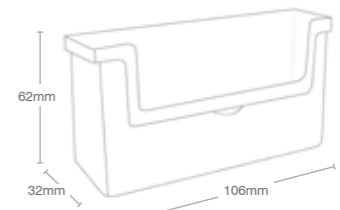

4. Single Page

A simple and extremely cost effective way to display your literature.
Both single and double sided options are offered to suit 1/3rd A4, A5 & A4 leaflets, menus or pricing information. Simply slot your literature between the clear PVC cover that allows total protection and simplicity to change. Alternatively, the base only can be supplied for use with oversize or die-cut cards.

Check all of the options at www.brochureholders.com

BASE ONLY

Base Only



L100B
1/3rd A4 Angled information holder base only
Carton quantity 260
Crystal Clear Polystyrene

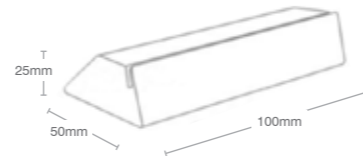

Base Only



L150B
A5 Angled information holder base only
Carton quantity 100
Crystal Clear Polystyrene

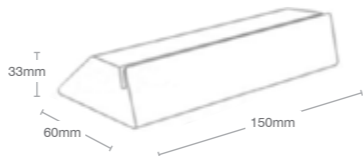

Base Only



L210B
A4 Angled information holder base only
Carton quantity 50
Crystal Clear Polystyrene

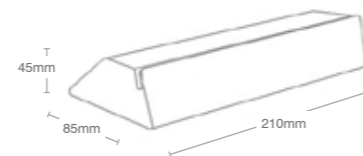

Base Only



M120B
120mm Menu holder base only
Carton quantity 256
Crystal Clear Polystyrene

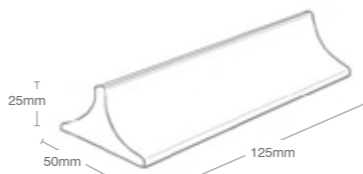

Base Only



M160B
A5 Menu holder base only
Carton quantity 192
Crystal Clear Polystyrene

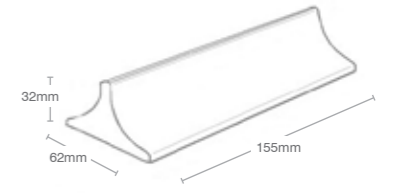

Base Only



M210B
A4 Menu holder base only
Carton quantity 96
Crystal Clear Polystyrene

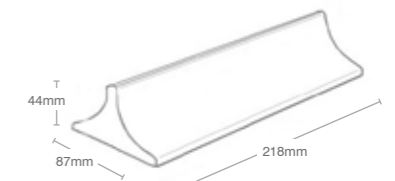

Base Only



V100B
1/3rd A4 Menu holder base only
Carton quantity 260
Crystal Clear Polystyrene

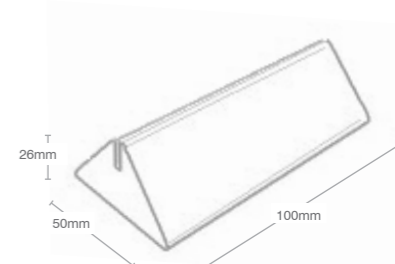

Base Only



V150B
A5 Menu holder base only
Carton quantity 100
Crystal Clear Polystyrene

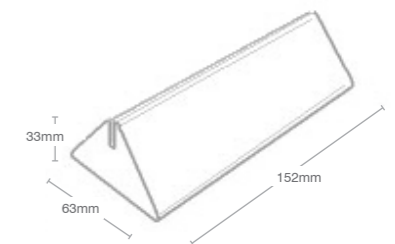

Base Only



V210B
A4 Menu holder base only
Carton quantity 50
Crystal Clear Polystyrene

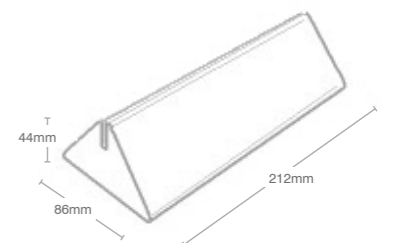

Base Only



PC260
Place card holder 80mm wide
Carton quantity 140
Crystal Clear Polystyrene

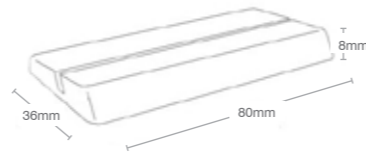

BASE & PVC

Base & PVC Top



L100
1/3rd A4 Angled information holder with PVC
Carton quantity 200
to hold: 210 x 100mm
Base: Crystal Clear Polystyrene - Top: PVC

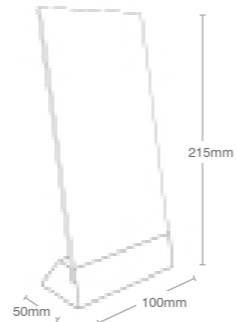

Base & PVC Top



V100
1/3rd A4 Menu holder with PVC
Carton quantity 200
to hold: 210 x 100mm
Base: Crystal Clear Polystyrene - Top: PVC

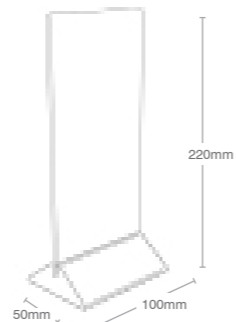

Base & PVC Top



M120
120mm Menu holder with PVC
Carton quantity 192
to hold: 135 x 120mm
Base: Crystal Clear Polystyrene - Top: PVC

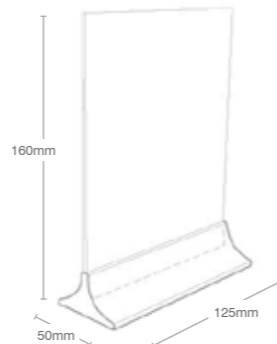

Base & PVC Top



AP150
A5 Angled ad-print with PVC
Carton quantity 60
to hold: 210 x 148mm
Base: Crystal Clear Polystyrene - Insert: PVC

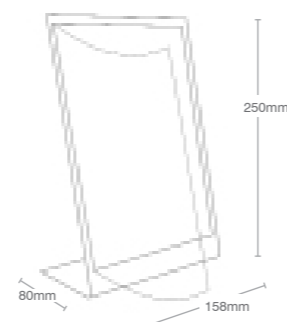

Base & PVC Top



L150
A5 Angled information holder with PVC
Carton quantity 80
to hold: 210 x 148mm
Base: Crystal Clear Polystyrene - Top: PVC

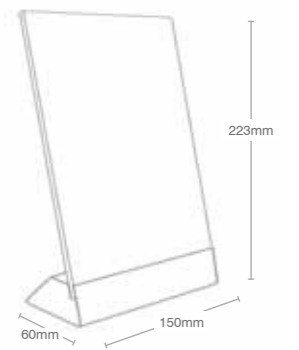

Base & PVC Top



V150
A5 Menu holder with PVC
Carton quantity 80
to hold: 210 x 148mm
Base: Crystal Clear Polystyrene - Top: PVC

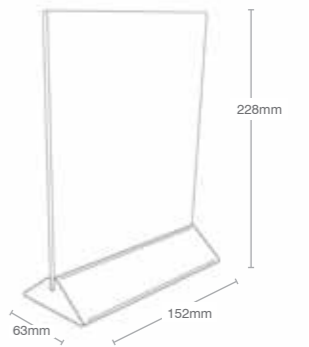

Base & PVC Top



M160
A5 Menu holder with PVC
Carton quantity 144
to hold: 210 x 150mm
Base: Crystal Clear Polystyrene - Top: PVC

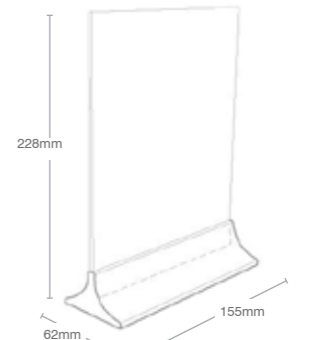

Base & PVC Top



AP210
A4 Angled ad-print with PVC
Carton quantity 60
to hold: 297 x 210mm
Base: Crystal Clear Polystyrene - Insert: PVC

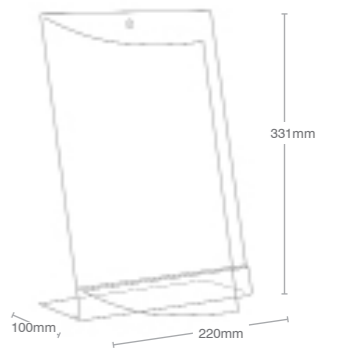

Base & PVC Top



L210
A4 Angled information holder with PVC
Carton quantity 40
to hold: 297 x 210mm
Base: Crystal Clear Polystyrene - Top: PETG

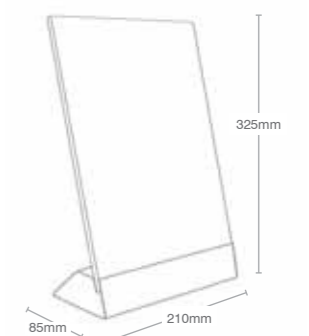

Base & PVC Top



V210

A4 Menu holder with PVC

Carton quantity 40
to hold: **297 x 210mm**
Base: Crystal Clear Polystyrene - Top: PETG

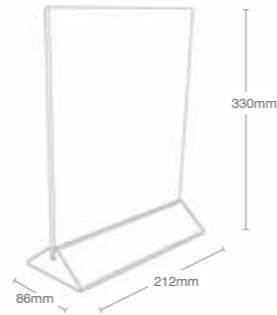

Base & PVC Top



M210

A4 Menu holder with PVC

Carton quantity 72
to hold: **297 x 210mm**
Base: Crystal Clear Polystyrene - Top: PETG

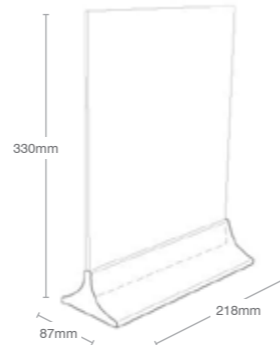

Base & PVC Top



NH210

A4 Notice holder with PVC - double sided
- window/wall mount - supplied with adhesive pads

Carton quantity 30
to hold: **297 x 210mm**
Base: Crystal Clear Polystyrene - Insert: PVC



5. Outdoor Leaflet Holders

A range of outdoor leaflet holders designed to suit all popular paper sizes. Weather and UV resistant.

Visit www.brochureholders.com for further details.

OUTDOOR HOLDERS

Outdoor



OD95

1 pocket landscape outdoor business card holder

Carton quantity 40
Opening dimensions: **95 x 25mm**
Crystal Clear Polystyrene

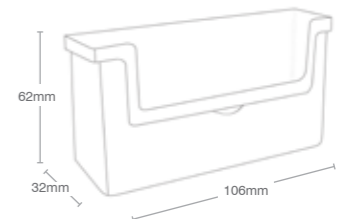

Outdoor



OD110

1 pocket 1/3rd A4/DL outdoor leaflet holder

Carton quantity 18
Opening dimensions: **110 x 32mm**
Crystal Clear Polystyrene

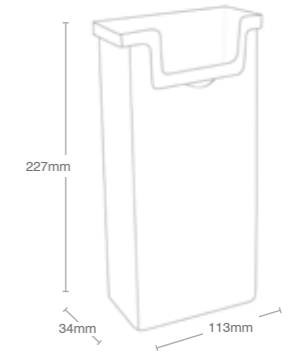

Outdoor



OD160

1 pocket A5 outdoor leaflet holder

Carton quantity 20
Opening dimensions: **160 x 32mm**
Crystal Clear Polystyrene

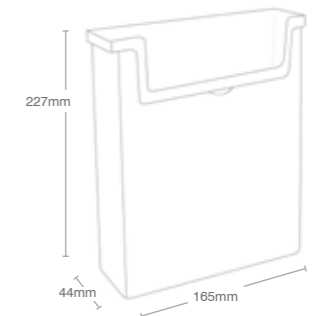

Outdoor



OD230

1 pocket A4 outdoor leaflet holder

Carton quantity 20
Opening dimensions: **230 x 32mm**
Crystal Clear Polystyrene

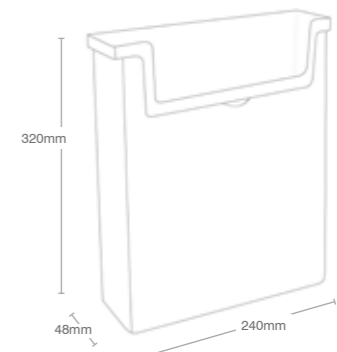

6. Floor Standing Carousels

A cleverly designed selection of rotary floor standing leaflet dispensers offering maximum versatility at minimum price. Choose from the contemporary and flexible 'mix and match' model or the traditional 'Classic' Taymar carousel.

Visit www.brochureholders.com to see the full range of floor standing carousels.

CAROUSELS

Carousels

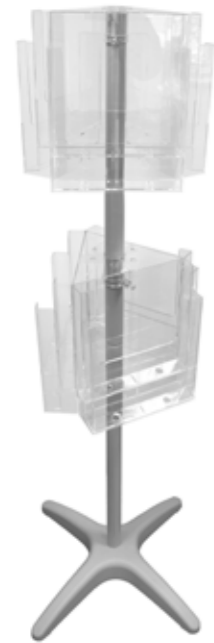

NEW

12RC230F
12 pocket A4 carousel

Opening dimensions: 230 x 32mm
Pockets: Crystal Clear Polystyrene

CD Pocket Dividers available separately to convert pockets to 1/3rd A4/DL

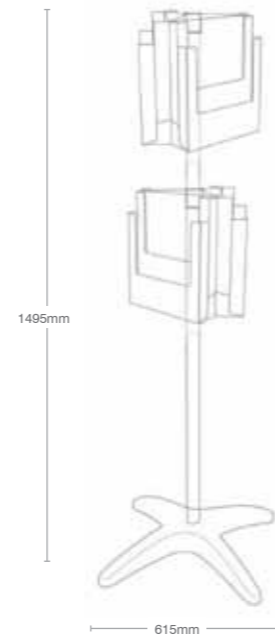

Carousels



CA1

'Mix and Match' carousel with any 3 tier combination - choose from:

- 12 Pocket 1/3rd A4 tier
- 6 pocket A4 tier
- 6 pocket A5 tier

Optional CAP210 A4 header available - see p. 26
Pockets: Crystal Clear Polystyrene

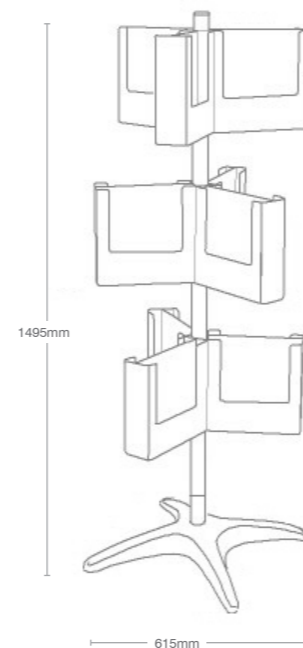

Carousels



MSC2

'Mix and Match' carousel with any 2 tier combination - choose from:

- 12 Pocket 1/3rd A4 tier
- 6 pocket A4 tier
- 6 pocket A5 tier

Pockets: Crystal Clear Polystyrene

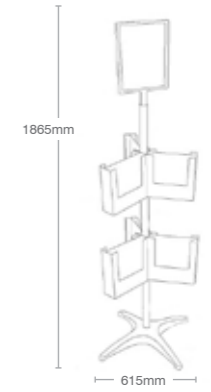

Carousels



NEW

6RC230

Additional tier for 12RC230F

Opening dimensions: 230 x 32mm
Crystal Clear Polystyrene

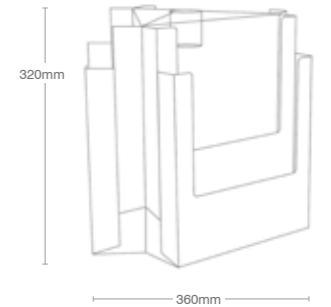

Carousels



12CA104

Additional 1/3rd A4 tier for CA1 or MSC kits

Opening dimensions: 104 x 32mm
Crystal Clear Polystyrene

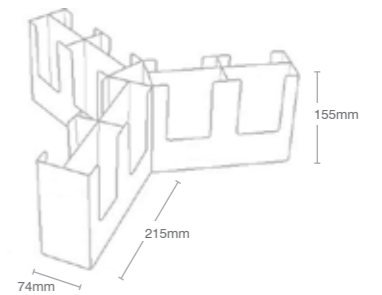

Carousels



6CA230

Additional A4 tier for CA1 or MSC kits

Opening dimensions: 230 x 32mm
Crystal Clear Polystyrene

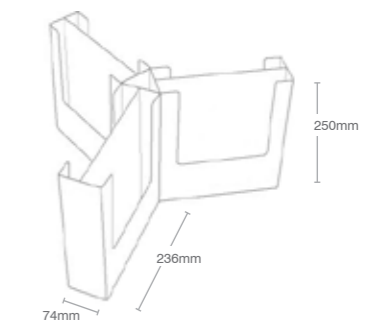

Carousels



6CA160

Additional A5 tier for CA1 or MSC kits

Opening dimensions: 160 x 32mm
Crystal Clear Polystyrene

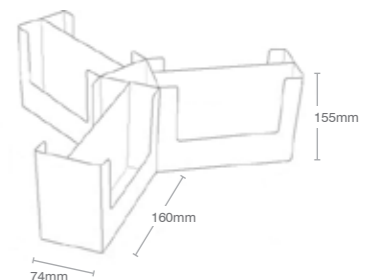

Carousels



12F230
 12 pocket A4 'Classic' carousel
 Opening dimensions: 230 x 32mm
 Pockets: Crystal Clear Polystyrene

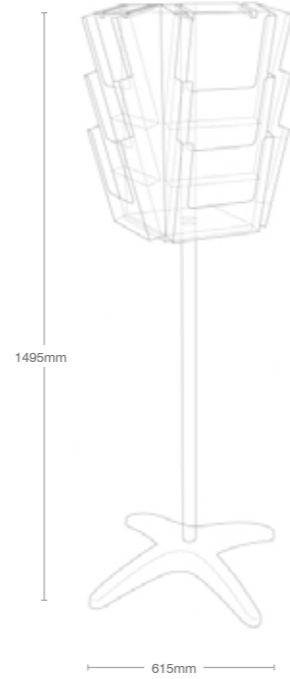

Carousels



24F230
 24 pocket A4 'Classic' carousel
 Opening dimensions: 230 x 32mm
 Pockets: Crystal Clear Polystyrene

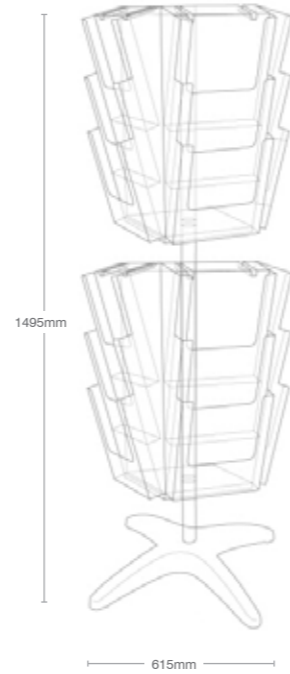

Carousels



CAP210
 Optional A4 header for use with CA1
 to hold: 297 x 210mm
 Frame: Polystyrene - Insert: PVC

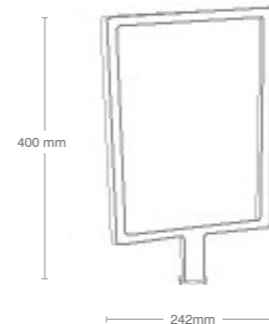

7. Desktop Spinners - Taymar

An eye-catching range of desktop spinners for 1/3rd A4, A5 and A5 literature. Each A4 spinner is compatible with our removable pocket dividers allowing pockets to be converted to 1/3rd A4 if required. Choose from three, four, six, or twelve pocket models.

Visit www.brochureholders.com to see the full range of desktop spinners.

TAYMAR DESKTOP SPINNERS

Desktop Carousels



6RC230C
 6 pocket A4 desktop carousel
 Opening dimensions: 230 x 32mm
 Pockets: Crystal Clear Polystyrene

CD Pocket Dividers available separately to convert pockets to 1/3rd A4/DL

NEW

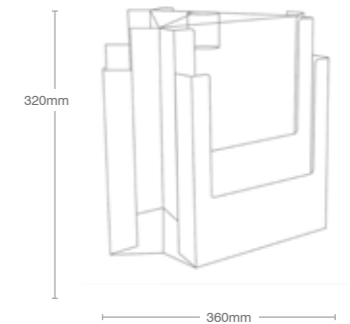

Desktop Carousels



12C230
 12 pocket A4 desktop carousel
 Opening dimensions: 230 x 32mm
 Pockets: Crystal Clear Polystyrene

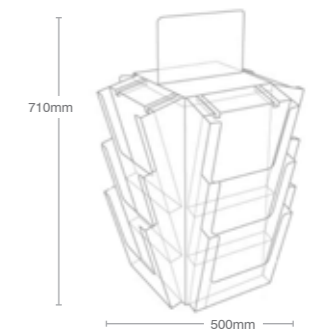

8. Desktop Spinners - ClipLock

An attractive selection of desktop spinners available for 1/3rd A4, A5 and A4 literature with three and four pocket models. Our competitively priced ClipLock spinners are supplied in kit form and are incredibly straight forward to assemble.

Visit www.brochureholders.com to see the full range of desktop spinners.



Assembly:

Each ClipLock spinner is supplied with all components and easy to follow instructions. Assembly takes no more than a couple of minutes.

The pockets are joined together using 'coupling clips' (image 1) and fixed to the spinner base using 'angled joining clips' (image 2).

Image 1

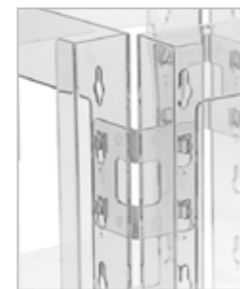

Image 2



CLIPLOCK DESKTOP SPINNERS

Desktop Carousel



CL-RS3108
 3 pocket 1/3rd A4 desktop spinner
 Opening dimensions: 108 x 32mm
 Pockets: Crystal Clear Polystyrene

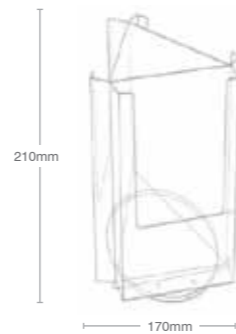

Desktop Carousel



CL-RS3152
 3 pocket A5 desktop spinner
 Opening dimensions: 152 x 32mm
 Pockets: Crystal Clear Polystyrene

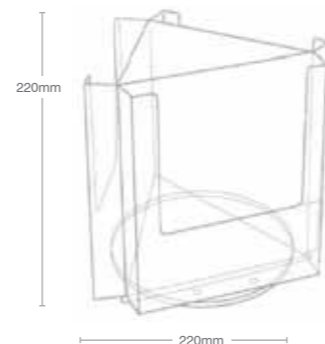

Desktop Carousel



CL-RS3223
 3 pocket A4 desktop spinner
 Opening dimensions: 223 x 32mm
 Pockets: Crystal Clear Polystyrene

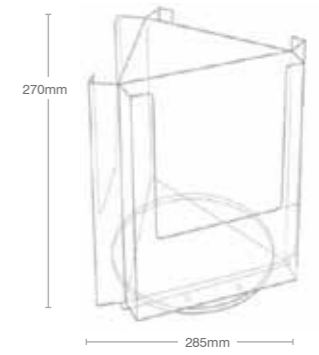

Desktop Carousel

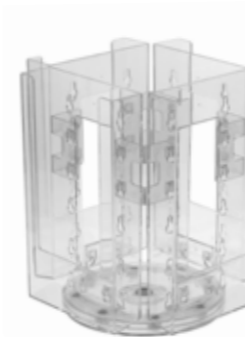

CL-RS4108
 4 pocket 1/3rd A4/DL desktop spinner
 Opening dimensions: 108 x 32mm
 Pockets: Crystal Clear Polystyrene

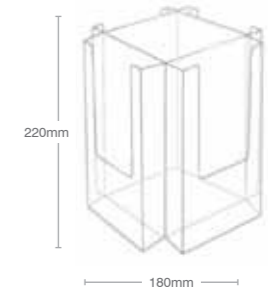

Desktop Carousel

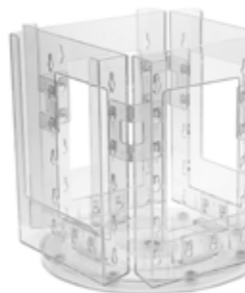

CL-RS4152
 4 pocket A5 desktop spinner
 Opening dimensions: 152 x 32mm
 Pockets: Crystal Clear Polystyrene

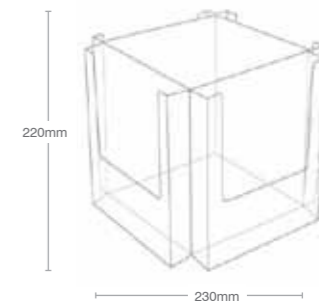

Desktop Carousel



CL-RS4223
 4 pocket A4 desktop spinner
 Opening dimensions: 223 x 32mm
 Pockets: Crystal Clear Polystyrene

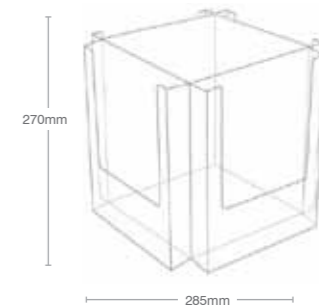

9. Floor Stands

A collection of floor standing display solutions. Completely free-standing and with a small footprint, Taymar floor stands can be positioned easily where required, ensuring maximum visual impact. Choose from two stand designs and a variety of models to suit 1/3rd A4, A5 and A4 literature.

Visit www.brochureholders.com for further details.

LUXURY FLOOR STANDS



AS3104
Luxury floor stand - 3 x 1/3rd A4 pockets
Opening dimensions: 104 x 32mm
Pockets: Crystal Clear Polystyrene



1050mm
330mm



AS4110
Luxury floor stand - 4 x 1/3rd A4/DL pockets
Opening dimensions: 110 x 32mm
Pockets: Crystal Clear Polystyrene



1085mm
330mm



AS3160
Luxury floor stand - 3 x A5 pockets
Opening dimensions: 160 x 32mm
Pockets: Crystal Clear Polystyrene

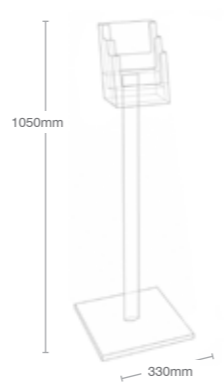

1050mm
330mm



AS4160
Luxury floor stand - 4 x A5 pockets
Opening dimensions: 160 x 32mm
Pockets: Crystal Clear Polystyrene

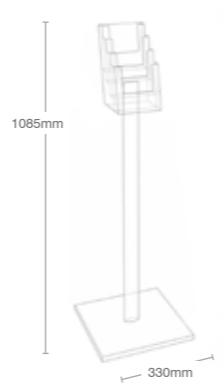

1085mm
330mm



AS3230
Luxury floor stand - 3 x A4 pockets - dividers available
Opening dimensions: 230 x 32mm
Pockets: Crystal Clear Polystyrene

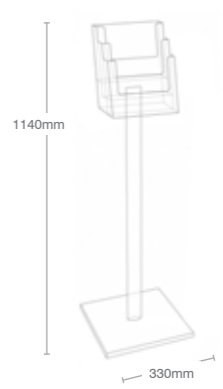

1140mm
330mm



AS4230
Luxury floor stand - 4 x A4 pockets - dividers available
Opening dimensions: 230 x 32mm
Pockets: Crystal Clear Polystyrene

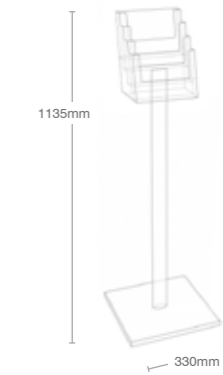

1135mm
330mm

FLOOR STANDS



FS4110
Floor stand - 4 x 1/3rd A4/DL pockets
Opening dimensions: 110 x 32mm
Pockets: Crystal Clear Polystyrene



1080mm
365mm



FS3110
Floor stand - 3 x 1/3rd A4/DL pockets side by side
Opening dimensions: 110 x 32mm
Pockets: Crystal Clear Polystyrene



1080mm
365mm



FS2155
Floor stand - 2 x A5 pockets side by side
Opening dimensions: 160 x 32mm
Pockets: Crystal Clear Polystyrene

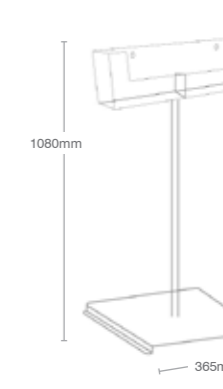

1080mm
365mm

Floor Stands



FS4160
Floor stand - 4 x A5 pockets
Opening dimensions: **160 x 32mm**
Pockets: Crystal Clear Polystyrene

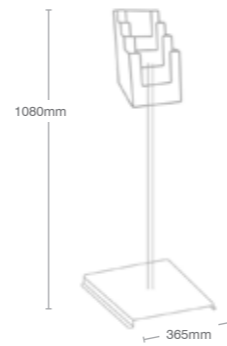

Floor Stands



FS3230
Floor stand - 3 x A4 pockets - dividers available
Opening dimensions: **230 x 32mm**
Pockets: Crystal Clear Polystyrene

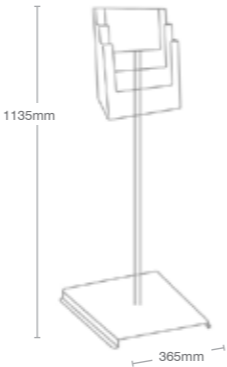

Floor Stands



FS4230
Floor stand - 4 x A4 pockets - dividers available
Opening dimensions: **230 x 32mm**
Pockets: Crystal Clear Polystyrene

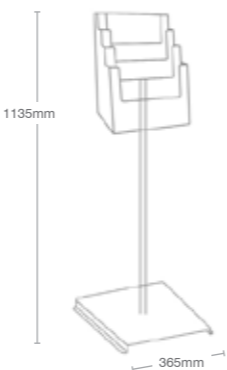

Floor Stands



FS330
1 x A4 landscape pocket
Opening dimensions: **330 x 32mm**
Pockets: Crystal Clear Polystyrene

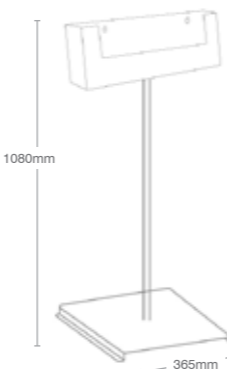

Floor Stands



FSP210
A4 notice holder
to hold: **297 x 210mm**
Pockets: Crystal Clear Polystyrene



10. Wall System

Probably the most ingenious and cost effective method to display all literature - even the most unusual paper sizes! Fully adjustable in width with versions for attaching directly to slat-wall or for use with our own aluminium wall strip (AL95). Alternatively, opt for the ready made kit system that is both easy to install and with stunning effect.

More details available by visiting www.brochureholders.com

Wall Mounted



Wall System

3 pocket adjustable width holders

Carton quantity 60 | Opening dimensions: **32mm**
Pockets: Crystal Clear Polystyrene

3PSW

3 pocket adjustable width holder stat-wall fitting

3PAS

3 pocket adjustable width holder AL95 fitting

Unique Adjustable Wall Mounting System

A superb, innovative product allowing for infinite flexibility in displaying your literature.

A product which can be set up to hold any size material, this system has the bonus that single pieces can be added on as required, with each additional module creating an extra 3 pocket display at less than half the cost of a standard brochure holder. This unique system has been developed for use in all types of locations, especially where wall space is limited.

Two versions have been developed:

3PAS - for use with our unique clip-on aluminium strip, AL95, incorporating a ticket strip facility. This system can turn whole walls into an adjustable display system which can be changed to accommodate any size material - standard or not - at any time. Cut aluminium strip to the required length and screw to wall or display board through the holes provided. The inclusion of a ticket strip enables you to highlight important information or special prices.

3PSW - for use with slat-wall displays; modules clip into standard slat and slides to the required position.

Each additional module provides 3 more pockets

Example:

Just 5 modules on the 95cm (37") strip provides a 12 pocket display of A4 (letterhead) size literature.
9 modules allows for a 24 pocket display of 1/3rd A4 (trifold) literature.
7 modules for an 18 pocket display of A5 (1/2 letterhead) literature.
Or mix and match to display your literature to maximum advantage

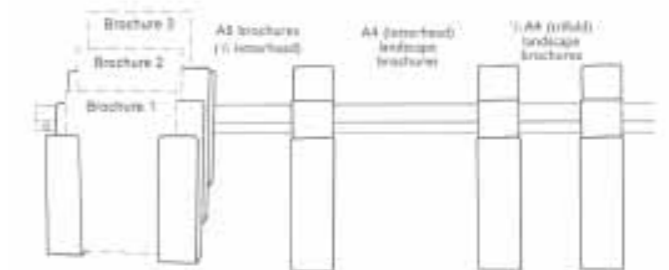

Wall Mounted



WS16-D8

A4 Wall-mounting kit providing 16 x A4 or 8 x A4 + 16 x 1/3rd A4 pockets

11. Accessories & Parts

Through clever use of simple adaptor clips, Taymar products become increasingly versatile. Easy to convert wall mounting holders for counter standing or to attach to slat-wall or to one another.

To see all options visit www.brochureholders.com

CLIPS

Clips



AB1

Free-standing clip for use on 4W104, W110, W160 & W230
Crystal Clear Polystyrene



Clips



CL-SMC

Surface mounting clips. Fixed to window / wall using adhesive OD products can be then be mounted and removed from clip.
Crystal Clear Polystyrene



Clips



CLW

Clip on clips used to hang products from one another or AL95 (maximum 3 products)
Polypropylene



Clips



CL-HC

Car window hanging clips used to hang OD products from car window.
Polycarbonate



Clips



HB1

Hanging clips used to hang wall mounted products (with keyholes) from wire frames or baskets
Polypropylene



Clips



SWB1

Slat-wall clips used to attach wall mounted products (with keyholes) to slat-wall
Crystal Clear Polystyrene



Accessories

ACCESSORIES



AL95

950mm Aluminium strip
Carton quantity 20



Accessories



CD

Pocket divider used to divide A4 portrait/landscape pockets
Crystal Clear Polystyrene



Accessories

LS101
100mm Lazy Susan



LS145
145mm Lazy Susan



LS225
225mm Lazy Susan



12. Screen Printing & Vinyl Labels

Add that little bit extra to your display!

Personalise holders with your company logo, a message or advertising slogan. We can offer you a customised printing service to apply your message, slogan or logo directly onto the brochure/information holder of your choice. The service includes Screen Printing or Vinyl Labels, both of which are fantastic ways to personalise Taymar products and achieve fantastic results.

Printing Areas

The following pages show the maximum screen printing area of each product in the Taymar range. In most cases, vinyl labels have slightly more flexibility and can also be applied to the sides of units as well.

Requirements

We are PC based. MAC files should be saved in PC format. Most common design and graphics programmes are supported. All fonts must be converted to curves, paths or outlines (Vector files). This avoids font matching and resolution problems and enables us to apply trapping or to make modifications to suit screen process print.

EPS & TIF Files: TIF files must be provided to highest possible resolution and should be at least 1200dpi. For line work all colours should be set as Pantone spot colours and not as CMYK.

Portable Document Files (PDF): PDF files are supported and all fonts must be converted to curves etc as above.

GIF – JPEG – BMP & Word files: GIF - JPEG - BMP and Word files are not acceptable for use as artwork. These files are normally not suitable for reproduction.

Camera ready Artwork: Camera ready artwork can be accepted but this will be scanned and converted to an electronic file.

Brochure Holder & Leaflet Holder Artwork Preparation

It is preferable to supply line artwork for these products but this does not rule out halftone or four colour process work provided the design allows for any screen resolution restrictions. We suggest that any tints are between 30% and 70%.

It is advisable to check the compatibility of your programmes with us before dispatching artwork. However, provided it is supplied as a vector file with all fonts converted to outlines there should not be a problem. Please ensure a proof is supplied showing any special instructions. Artwork should be adapted to suit screen process printing. Colour separations, trapping, order of printing colours can be significantly different to lithographic printing.

Brochure Holders & Colour Matching

Certain colours may appear slightly transparent when printed on to clear products. This is due to the pigments used in the manufacture of the inks. In many cases a background colour, such as White, will have to be printed.

Colour Matching

We use the Pantone reference system. If a reference colour is not available then a suitable swatch should be supplied. Adjustments have to be made to suit the substrate.

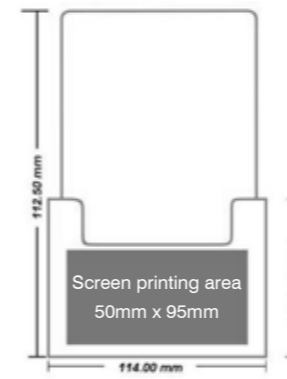

Products with this printable area:

C110

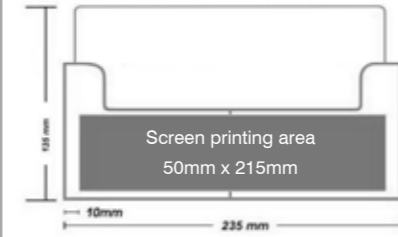

Products with this printable area:

**2CA6
2WA6
CLA5
WLA5**

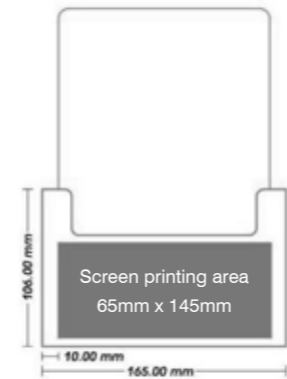

Products with this printable area:

C160

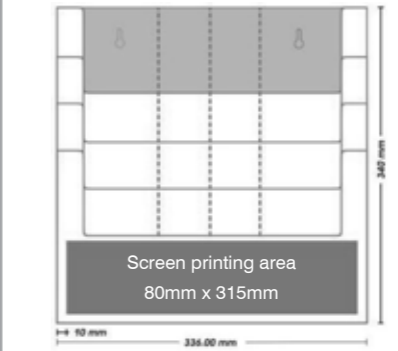

Products with this printable area:

**4C330
4C330X**

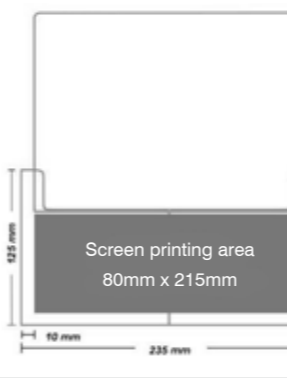

Products with this printable area:

**C230
2C112**

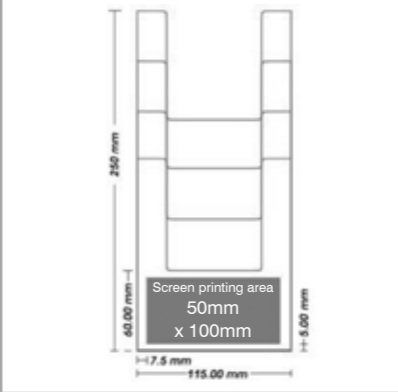

Products with this printable area:

4C110

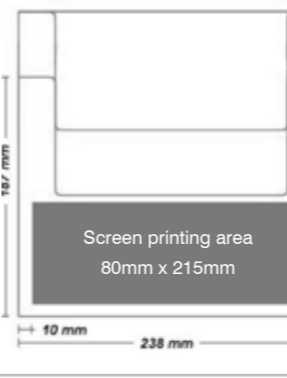

Products with this printable area:

**2C230
2C230X
3C230
4C230
4C230X**

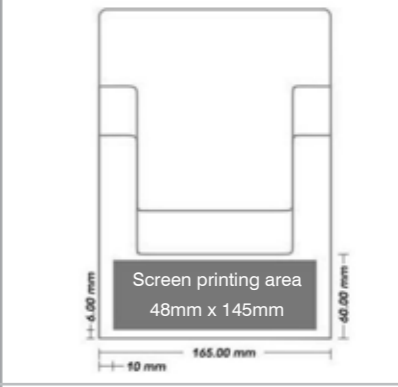

Products with this printable area:

**2C160
3C160
4C160**

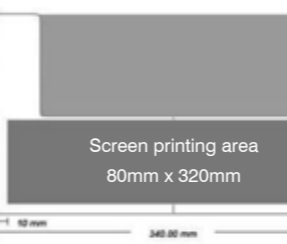

Products with this printable area:

**C330
3C110H
2C155H**

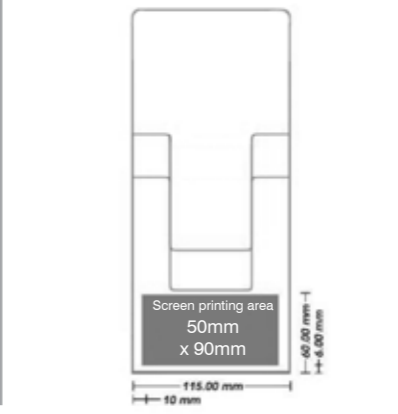

Products with this printable area:

**2C110
3C104**

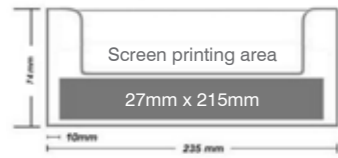

Products with this printable area:

CL230
WL230

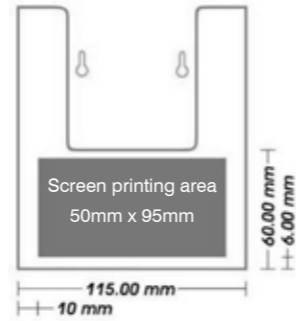

Products with this printable area:

WPA6
WPA6X

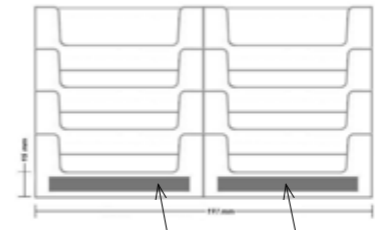

Products with this printable area:

8BC93

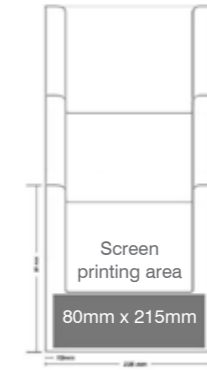

Products with this printable area:

3W230

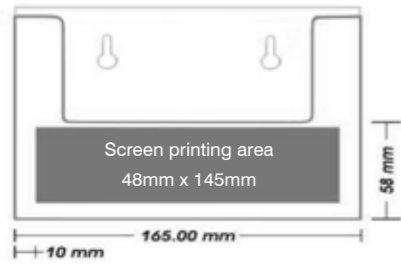

Products with this printable area:

WLA6
WLA6X

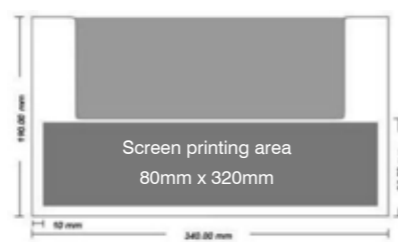

Products with this printable area:

W330
3W110H
2W155H

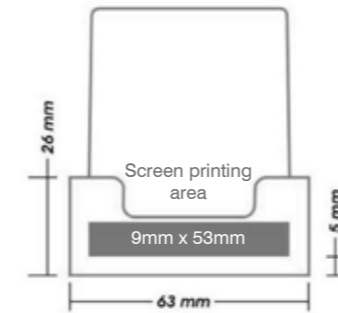

Products with this printable area:

VBC56

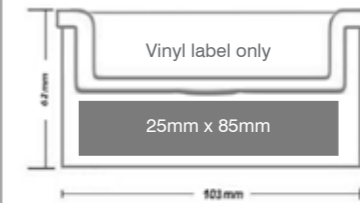

Products with this printable area:

OD95

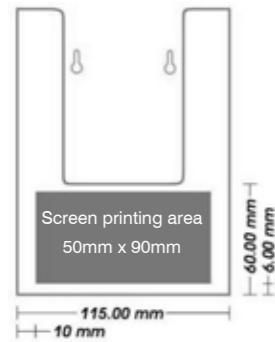

Products with this printable area:

W110
W110X

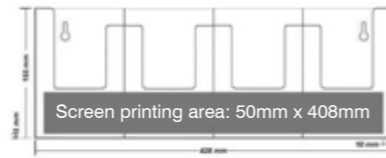

Products with this printable area:

4W104

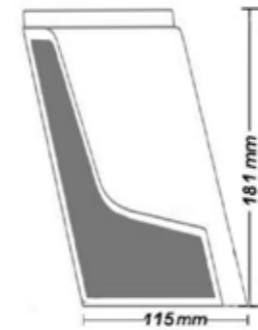

Products with this printable area:

TS110

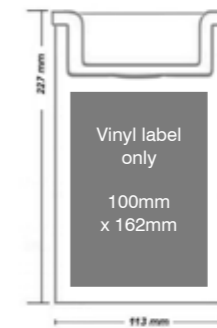

Products with this printable area:

OD110

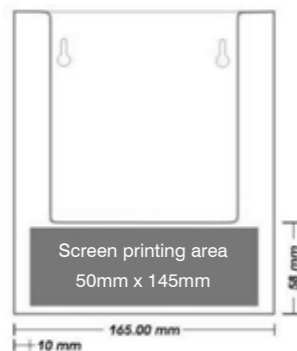

Products with this printable area:

W160
W160X

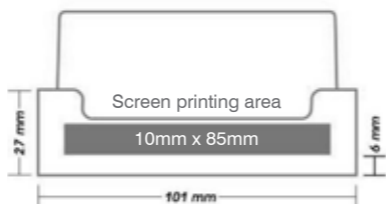

Products with this printable area:

BC93

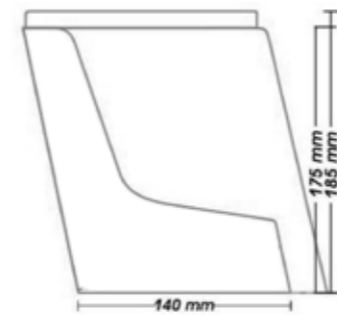

Products with this printable area:

TS160

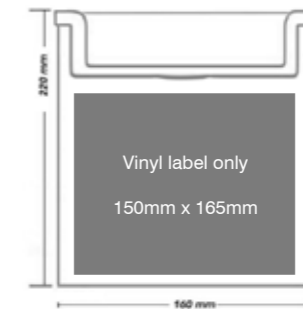

Products with this printable area:

OD160

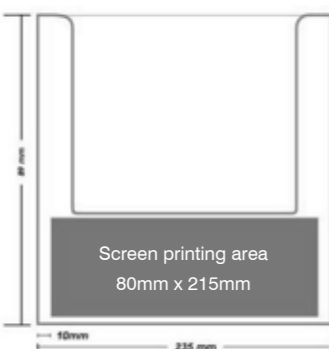

Products with this printable area:

W230
W230X

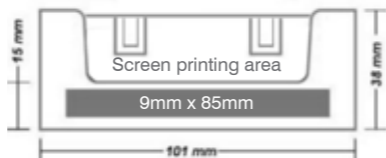

Products with this printable area:

4BC93
NB93
WBC93
CWBC93



Products with this printable area:

TS230



Products with this printable area:

OD230

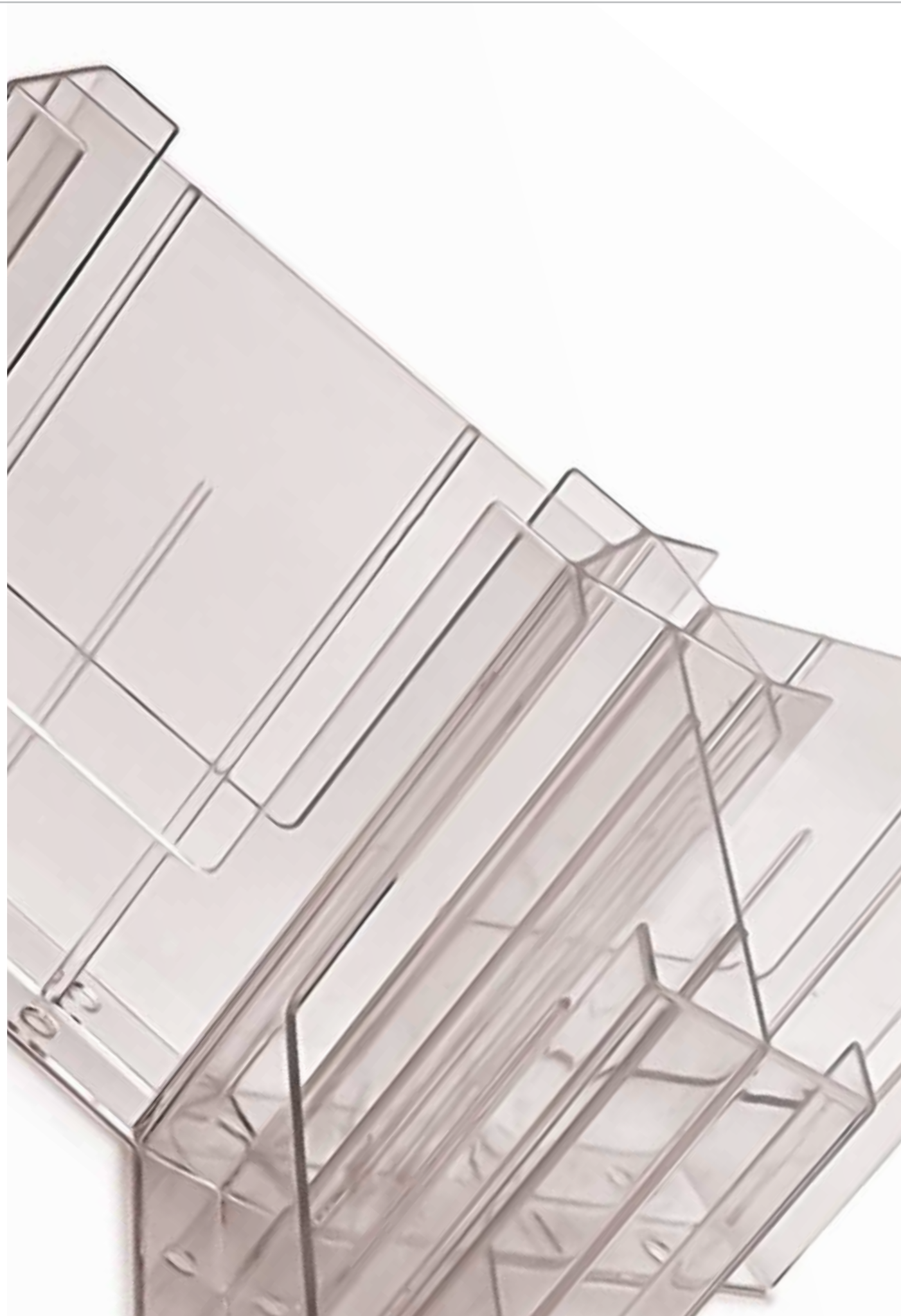

The last word

Thank you for looking through our brochure. We hope we have been able to supply you with a cost effective and attractive solution for your display requirements and that Taymar products will be able to help you to show your literature effectively but simply.

For further details and product specifications please visit www.brochureholders.com or call us to discuss your requirements or answer any questions.

The Taymar team at Brochure Holders International look forward to hearing from you very soon.

Brochure Holders International Ltd
Unit 1, Holywells Road, Ipswich
Suffolk, IP3 0DL. United Kingdom

Tel: +44 (0)1473 229250
Fax: +44 (0)1473 229251

sales@brochureholders.co.uk
accounts@brochureholders.co.uk

www.brochureholders.com



Brochure Holders International Ltd
Unit 1, Holywells Road, Ipswich
Suffolk, IP3 0DL. United Kingdom

Tel: +44 (0)1473 229250

Fax: +44 (0)1473 229251

sales@brochureholders.co.uk

accounts@brochureholders.co.uk

www.brochureholders.com